

User Manual



AUDIOVOLT



Accessories

Power cable



CAN-Q5U

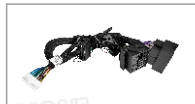

CAN-A6



CAN-A8



CAN-C6



CAN-Q3S-V4



CAN-A7C



CAN-B9



CAN-Q5L



CAN-Q3H



CAN-A6 RMC

Common cables



LVDS cable



Wifi antenna



USB cable

Extra cable for RMC and Q5L



Mic adapter cable



Microphone

DIP code setting

Model	Year	System version	DIP code	CAN cable	BOX label
Q5	13-18	3G MMI	000000/001110 (System version - Bnav)	Q5U	Q5H
S4/S4/A4/A5	12-16	3G MMI			
S4/S4/A4/A5/Q5	10-12	3G MMI	000111/001110 (System version - Bnav)		
S6/S7/A6/A7	12-16	3G MMI	000000	A6	
A8	10-18	3G MMI	000001	A8	
A6/A7 RMC	12-16	3G MMI	High CAN connection 000000 / 000001	A6 RMC	A6 RMC
			LOW CAN connection 001110		
S6/A6(C6)	10-11	3G MMI	001101	C6	Q5H
Q7	10-15	3G MMI	000010		
S6/S7/A6/A7	16-18	MHI2	001111	A7C	
S3/A3	14-16 (5.8/6.3)	MIB	110011	B9	
S3/A3	14-16 (7 inch)	MIB	111001		
S3/A3	17-18 (6.3 inch)	MIB	110110		
S3/A3	17-18 (7 inch)	MIB	111000		
Q2	19 (7 inch)	MIB2			
B9/A4/S5/A5	14-19 (7 inch)	MIB2	110100		
Q7	16-18	MIB2	111011		
Q5	18-19 (7 inch)	MIB2			
Q3 with navi	14-18 (7 inch)	2G MMI	001100	Q3H	
Q3 no navi	14-18 (6.3 inch)	2G MMI	001100	Q3S-V4	
A1	14-18 (5.8/6.3 inch)				

Model	Year	System version	DIP code	CAN cable	BOX label
Q5/A4/A5 (NO MMI)	10-18 (6.3 inch)	2G MMI	000101	Q5L	Q5L
A4/A5	14-19 (8.3 inch)	MIB2	110100	B9	Q7
Q7	16-19 (8.3 inch)				
Q5	18-19 (8.3 inch)				
Q2	19 (8.3 inch)				

The 7th dip code is for parking button setting: if the original car has a parking button, set to OFF;

if the original car not have a parking button, then set to ON;

The 8th dip code: If the original car has a microphone, set to OFF; if the original car not have Bluetooth,

then set to ON (need to install our microphone);

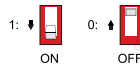

Product features

1. Wireless Apple CarPlay/Android auto, pairing via Bluetooth, transfer via WIFI.
2. Support Airplay/Autolink
3. Work Wired CarPlay, turn off wifi at first, and connect via lighting cable (meanwhile wired keep your phone charged)
4. Enjoy your favorite videos and music.
5. Voice control by saying "Hey Siri..."
6. Aftermarket front/rear/360 camera input. (Support Dynamic guidance lines)
7. U-disk to play music and videos by connecting USB port from CarPlay kit
8. Support original BT to play sound and make phone call
9. Full OEM buttons control.
10. HDMI input, with HDMI device to get more high-definition video.

Connection for A4/A5/Q5 3G MMI

Model	DIP code
2013-2018 Q5 3G MMI+ (HN+R)	000000
2013-2014 A5 S5 (7 inch)	000000
2012-2015 A4 A5 (HN+R)	000000
2010-2012 Q5 3G MMI (HN+R)	000111
2010-2011 A4 A5 3G MMI	000111
2010-2016 A4 A5 Q5 B8 (Bnav system)	001110

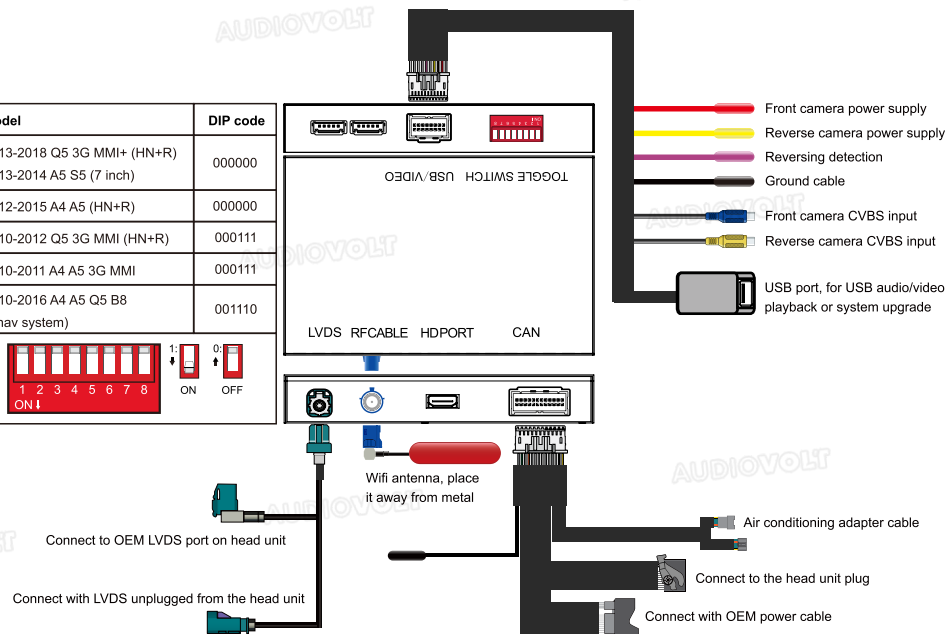
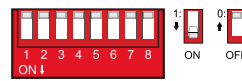

Connection for A4/A5/Q5 None MMI 2G High

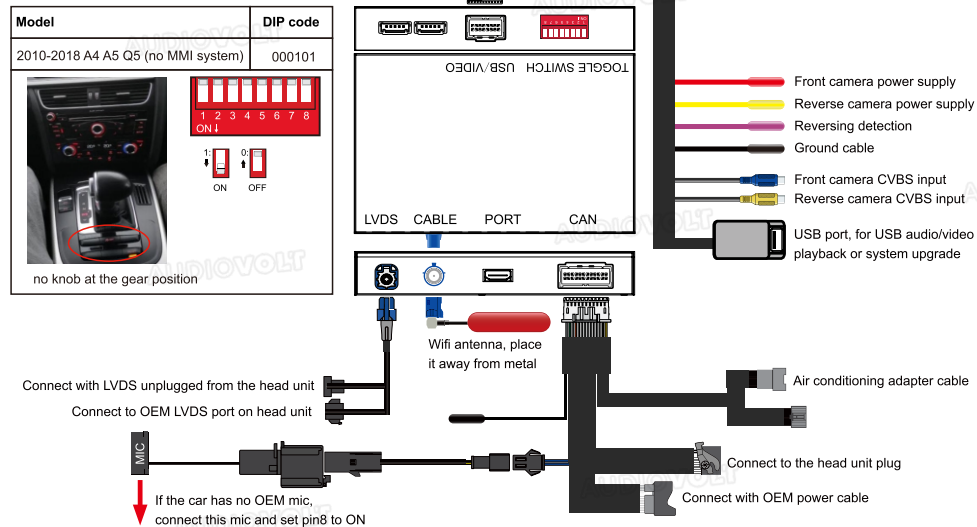

FPC connection

1. Transfer panel button cable, fix the transfer board with original car screws after connection
2. Power needs to be disconnected during installation.

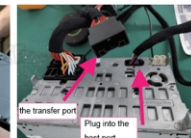
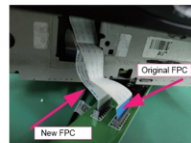

Complete the transfer of air conditioning panel

Unplug power cable of the head unit

Plug into the host port

Note:

1. The blue marked area cannot be bent or broken, otherwise it may affect the original car system and make it unable to start. (Fig 1)
2. Pay attention to the direction of FPC while plugged in slots as shown in the pics. (Fig 2)

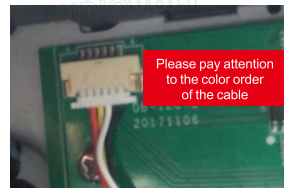

Please pay attention to the color order of the cable

Connection for Q3/A1 RMC system (New circuit board)

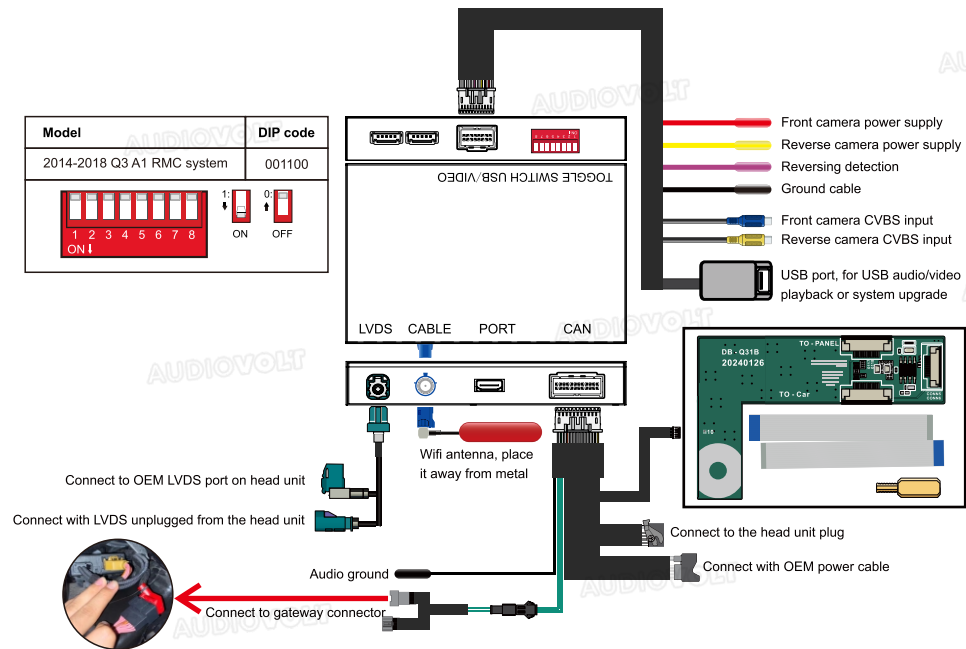

Q3 FPC Adapter Board Installation

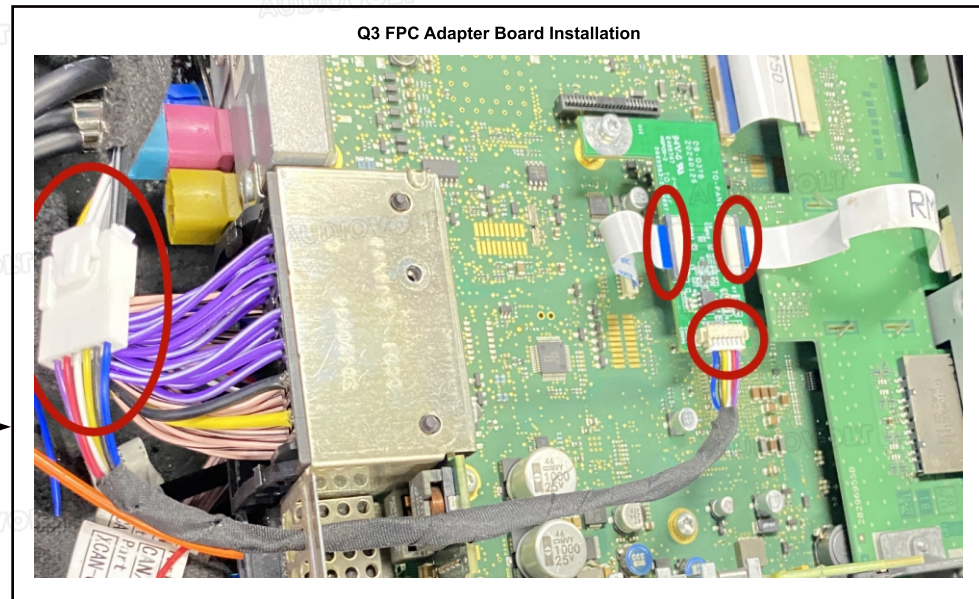

Connection for Q3/A1 RMC system(Old circuit board)

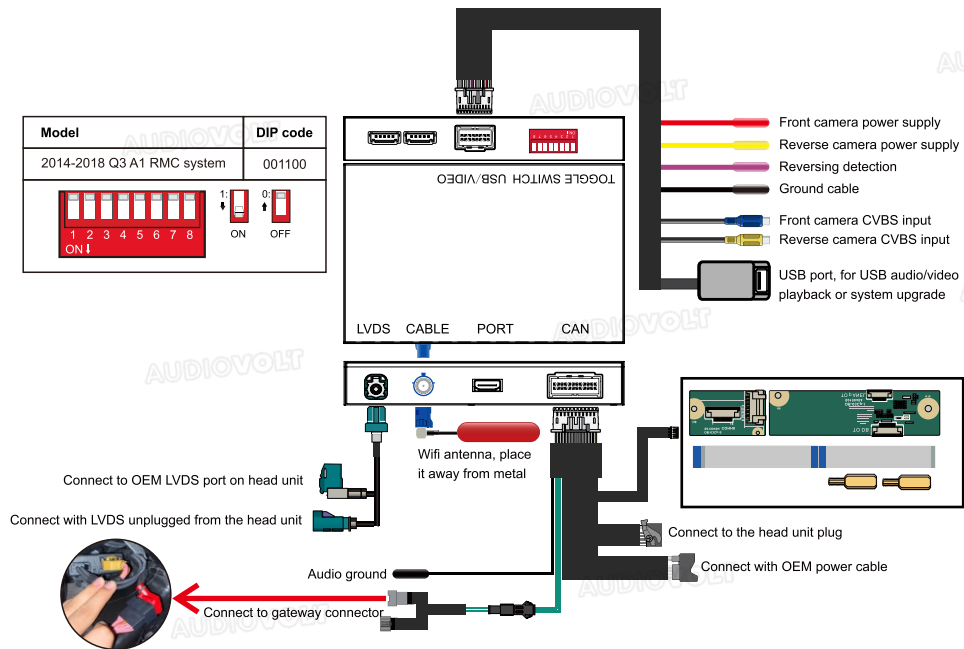

Q3 FPC Adapter Board Installation

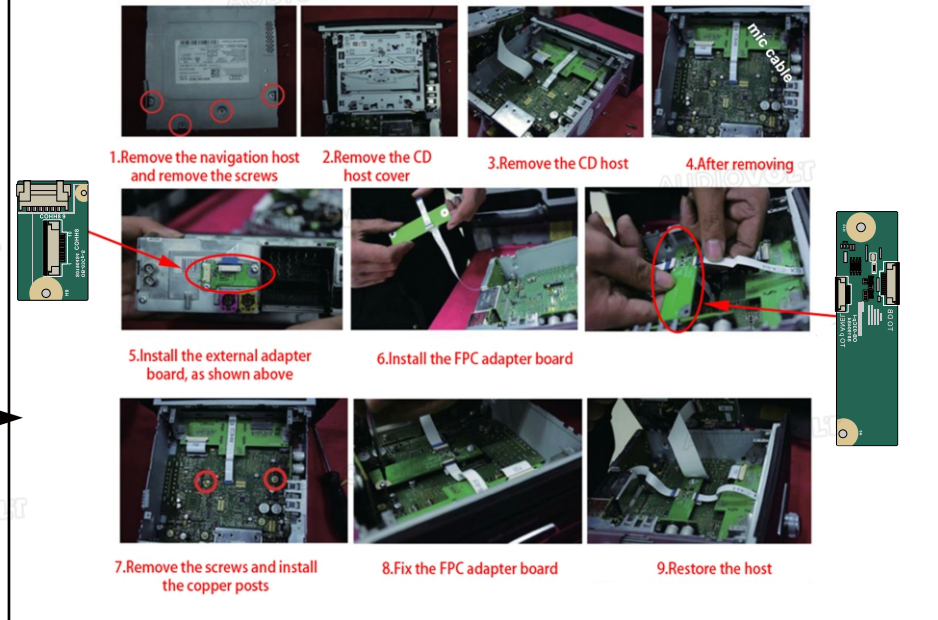

Connection for Q3 HN+

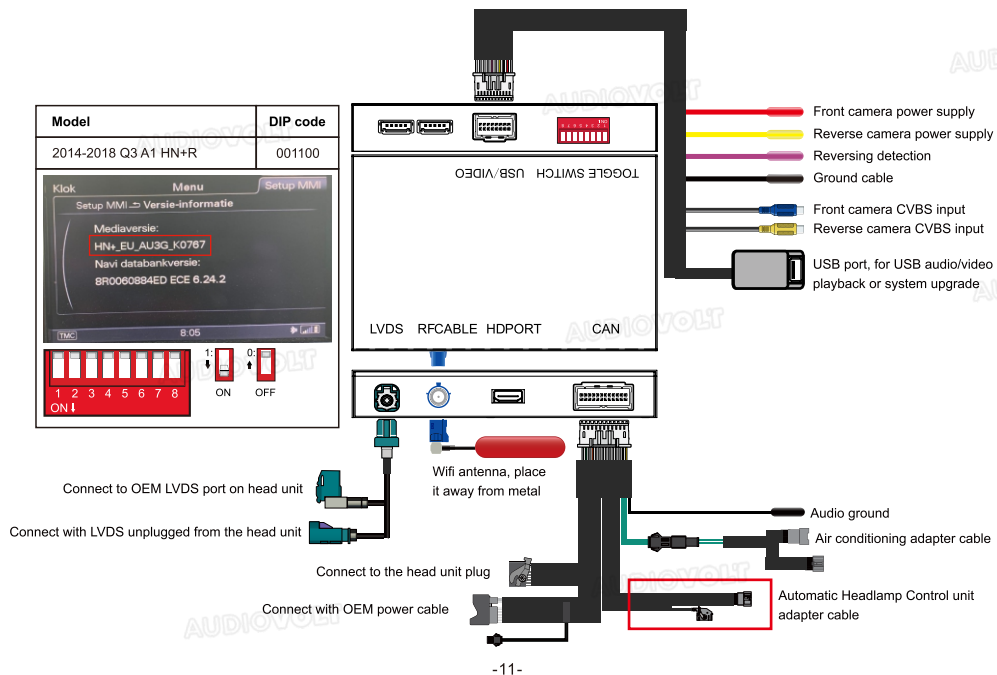

Connection for A8

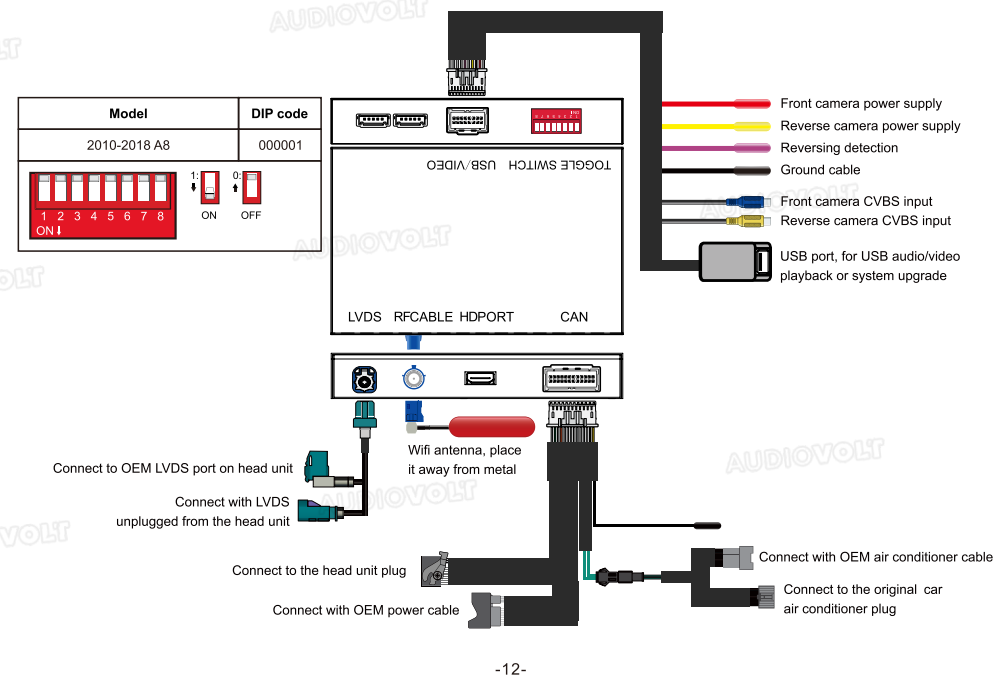

Connection for A6 A7 C7 HN+ and MH12

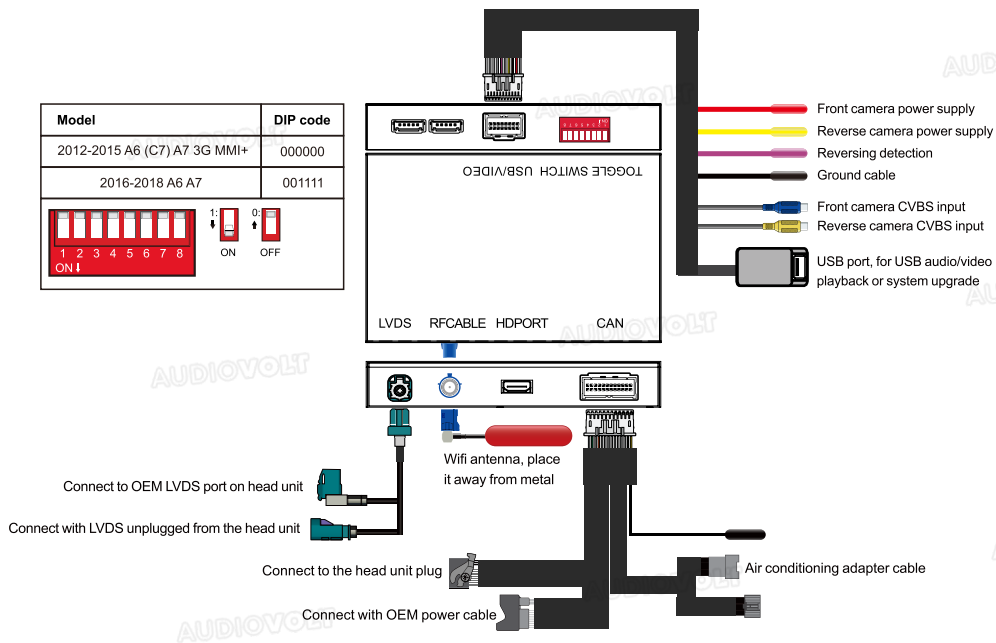

Connection for 2010-2011 A6 C6 and 2010-2016 Q7

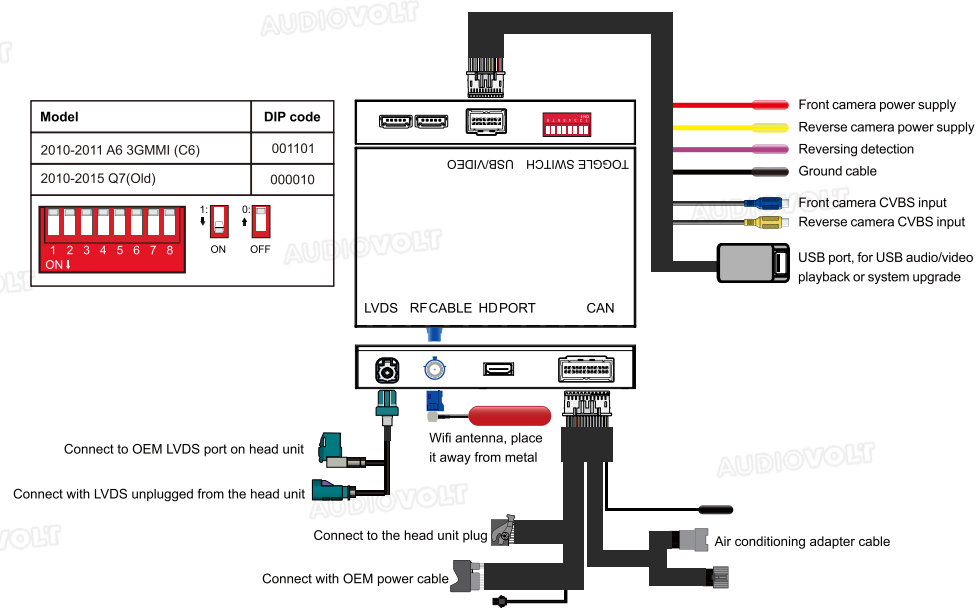

Connection for A3/S3/RS3/A4/S4/RS4/A5/Q7 MIB II (7 inch Screen)

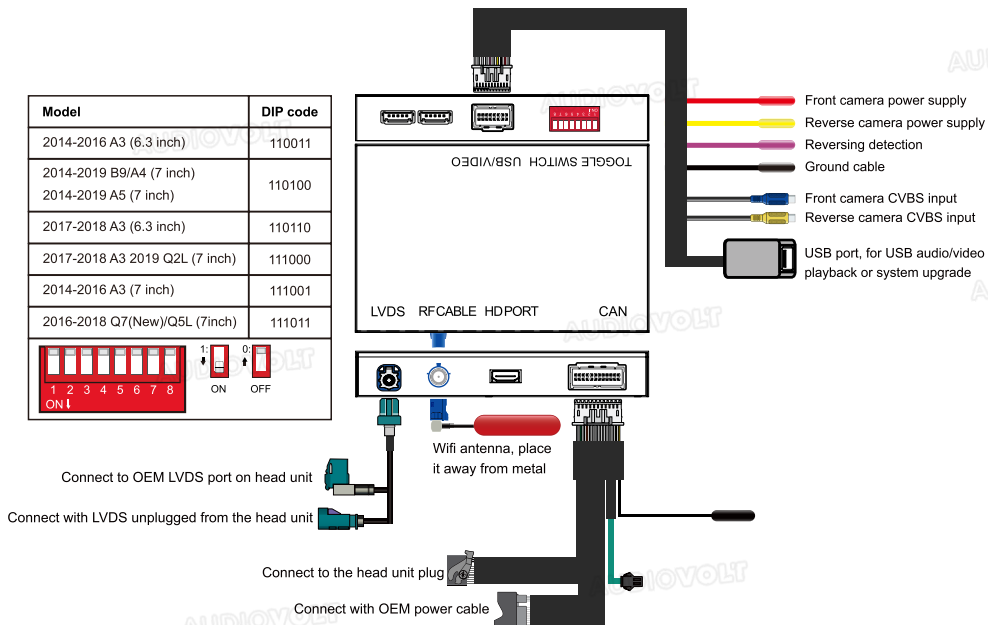

Connection for S3/RS3/A4/S4/RS4/A5/Q7 MIB II (8.3 inch Screen)

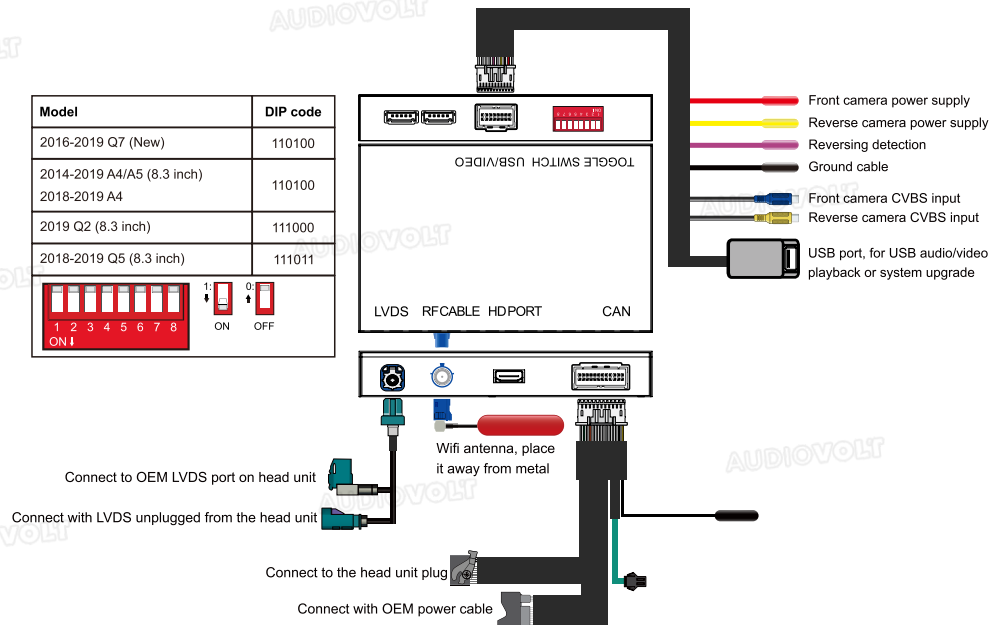

Connection for A6/A7 RMC system

Model	DIP code
2012-2016 (5.8 inch)	High-speed: 000000
2012-2016 (5.8 inch)	High-speed: 000001
2012-2016 (5.8 inch)	Low-speed: 001110

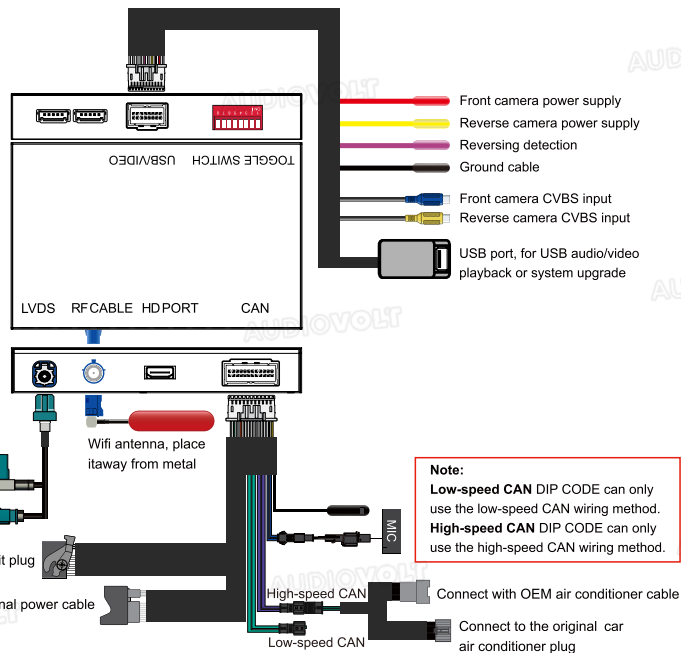

Note:
Low-speed CAN DIP CODE can only use the low-speed CAN wiring method.
High-speed CAN DIP CODE can only use the high-speed CAN wiring method.

Original car button definition



A6 3G MMI controller



A4 3G MMI controller



A8 3G MMI controller

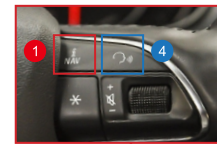

Steering wheel buttons



Q3/A1 controller



A3 MIB II controller



Q5L controller

- 1 System switching: long press 3s to switch between Carplay and OEM
- 2 Move the pointer: turn the dial
Confirm: short press
Activate siri/google assistant: long press 5s in carplay system
- 3 Back to the previous menu: short press
Restart box: long press 5s
- 4 Activate siri/google assistant: long press 3s

Wireless CarPlay

Wireless carplay and Android auto connection steps

1. Turn on the Bluetooth visible option in the settings.
2. Return to the system main interface and click the CarPlay icon.
3. Turn on the wifi and Bluetooth options in the phone settings. Use the phone to search for the Bluetooth name EW-XXXX.
4. Click Pairing-Allow-Use carplay on the phone. The system will automatically connect successfully.

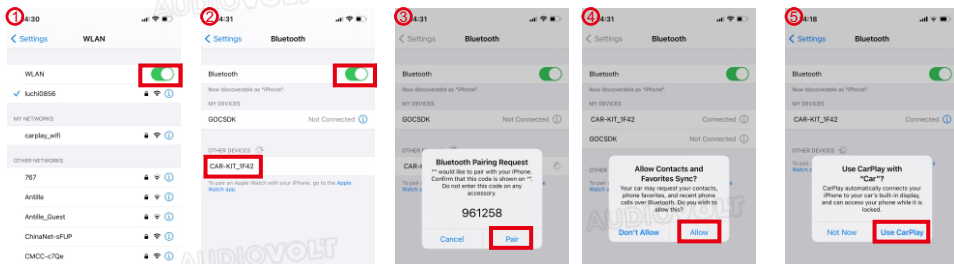
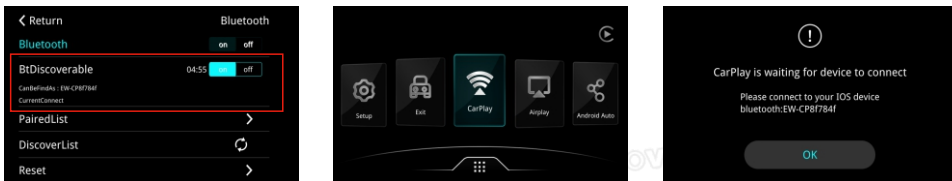

If wireless carplay cannot be connected:

1. Click on the carplay Bluetooth (EW-CPXXX) on the phone to reconnect
2. Clear the Bluetooth devices on the phone and the car, and then pair and connect,
3. Restore the mobile network on the phone
4. Check whether CarPlay on your phone is turned on. (Settings - Screen Usage Time - Content and Privacy Access Permissions - Allowed APP)
5. Turn on all Siri permissions
6. If necessary, check whether the wifi antenna is installed correctly (keep away from metal)

Wireless CarPlay disconnection method:

1. Disconnect the Bluetooth connection between the phone and the box.
2. Turn off wifi in the phone settings

Wireless Android Auto

- (1) Turn on the CarPlay MMI, select Bluetooth in the system [Settings], and make the Bluetooth visible.
- (2) Return to the system's main interface and click the [Android Auto] icon.
- (3) Ensure the phone's Bluetooth, Wi-Fi, and location services are turned on during the setup. Then, go to [Settings] > [Bluetooth] on the phone, search for the Bluetooth name (EW-CPXXX), and click to pair.
- (4) After the phone successfully pairs with the vehicle via Bluetooth, Android Auto will start within a few seconds. If it does not start automatically, follow the prompts on the screen to launch Android Auto. Note: You may need to tap the Android Auto icon on the vehicle screen.

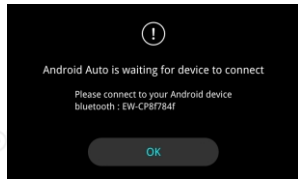
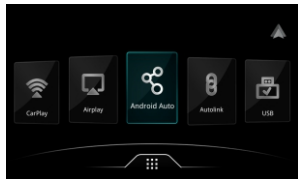

Wireless Airplay

Please note: Disconnect the Bluetooth and WiFi connections of CarPlay before connecting.

- (1) Click the **[AirPlay]** icon in the main menu.
- (2) On your mobile phone, find the corresponding SSID in WiFi settings (e.g., EW-CPXXXX) and enter the password 88888888.
- (3) Bring up the phone's menu bar, select Screen Mirroring from the menu options, and then click AirPlay to complete the mirroring.

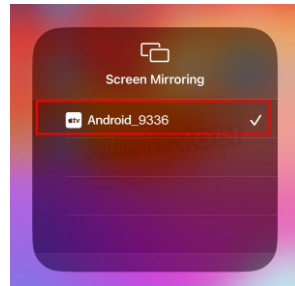
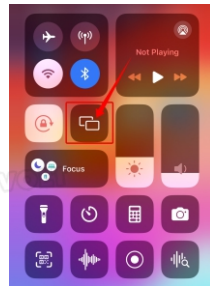
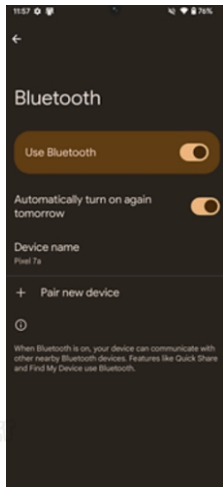
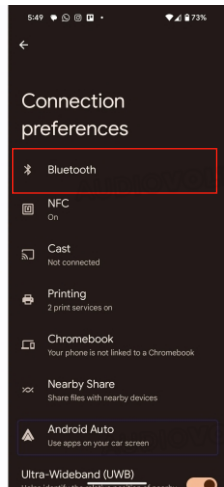
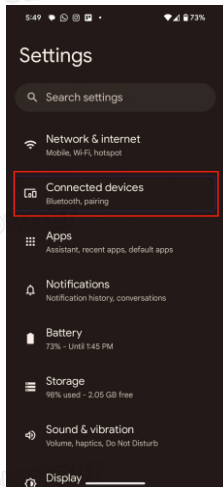
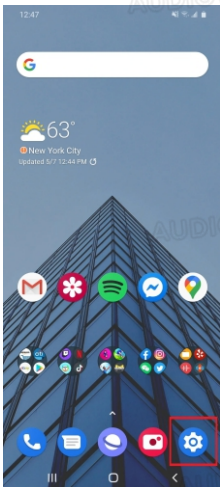
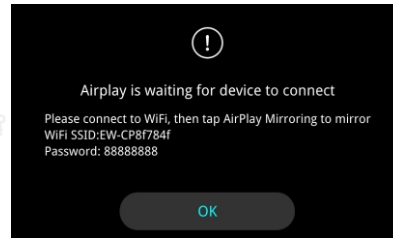
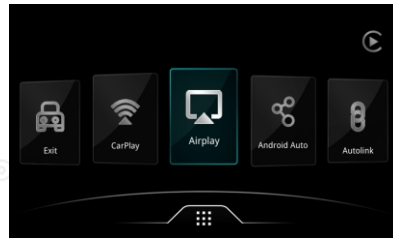

Wired Autolink

(1)Click the **[Autolink]** icon on the screen and select "Confirm."

(2)Connect the mobile phone to the USB port of the MMI box via a data cable. The mobile phone will prompt you to enter the browser to download and install the "Autolink APP."

(3)Reopen the Autolink APP on the mobile phone and unplug the data cable.

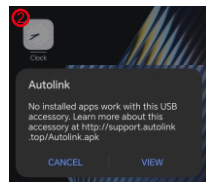
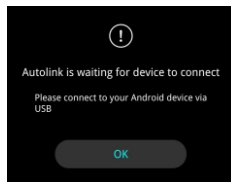
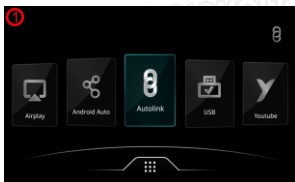

YouTube

(1)Click the **[YouTube]** icon on the screen to enter the program.

(2)Turn on the mobile phone hotspot. Search for the phone's Wi-Fi name on the car screen and enter the password.

(3)Wait for YouTube to connect successfully.

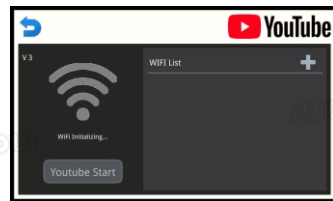
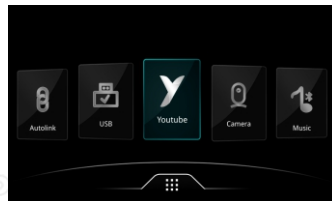

Bluetooth music and Bluetooth phone function

Make sure the phone is disconnected from the wireless Carplay/Android Auto, then connect the box's Bluetooth, and then click the Bluetooth music or Bluetooth phone icon to use these two functions

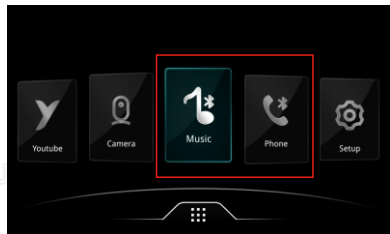

USB Music & HD Video Playback

1. Insert the USB with video and music files first, click the **[USB]** icon

2. Switch between music and video functions, click the three dots in the upper right corner to select audio or video function

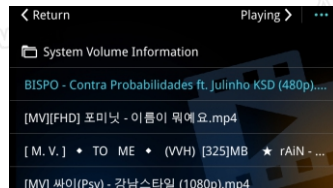
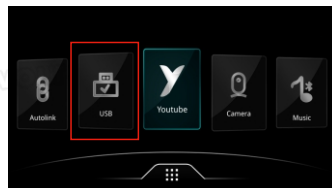

Frequently Asked Questions(FAQ)

1. How to set the language?

Enter the **[Setup]** icon. Select the language option. Set the corresponding language.

MMI box supported languages: Chinese, English, Italian, Polish, Spanish, Turkish, French, Korean, Portuguese, German

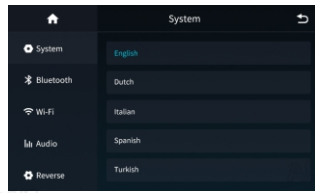
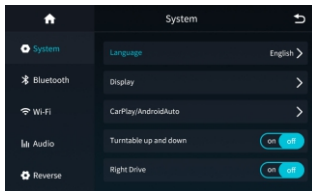
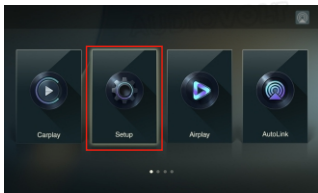

2. How to use the original Bluetooth channel function?

1. Turn on setting **[Use original car's BT channel]**

2. Search and connect original car's BT on phone first

3. Search and connect carplay's BT 'EW-CPXXX'

4. Select Bluetooth audio output in the original system. Carplay will play music and navigation sounds.

The screen mirroring and USB audio and video functions cannot be output when using the original car Bluetooth.

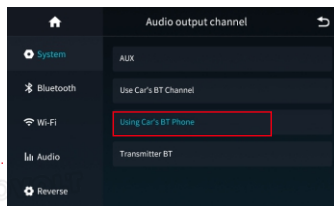

3. How to set the Reverse option

Automatic transmission:

(1) Attach the reverse camera to the CVBS port labeled "Reverse Camera."

(2) Connect the yellow cable labeled "12V Reverse Camera" to camera's power supply..

(3) Navigate to Settings > Reverse > Reverse Camera > Aftermarket.

(4) Ensure the camera option is set to Aftermarket. In the reverse camera settings, set the Reverse Line to OFF. All other options should remain at their default settings.

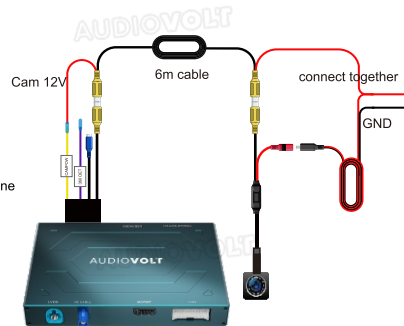
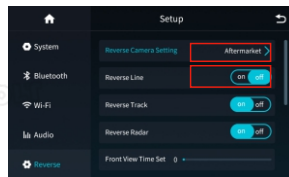

Manual transmission

(1) Connect the reversing camera to the CVBS "Reversing Camera."

(2) Connect the purple cable labeled "Reversing Detection 12V" to the camera's power supply.

(3) Click Settings > Reversing > Reversing Camera > Aftermarket

(4) Set the camera option to "Aftermarket". Ensure the reverse line is set to "ON".

Other options remain unchanged.

(5) Connect the rear-view camera's power wire to the "12V" power supply of the reverse light

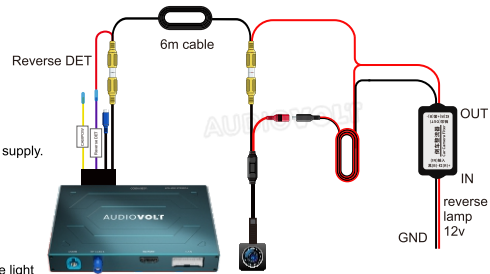

(Rectifier version)



*For vehicles equipped with an original camera, select the camera option "Original" and ensure the reverse wire option is set to "OFF" .

All Other options remain unchanged.

4. Reversing option function description

*You can choose the front camera display time from 0~15s.

*If the vehicle is equipped with an aftermarket 360 camera (not the original 360 camera).

You need to set the matching 360 camera to ON in the reversing settings.

*Front Camera Mirror ON/OFF

*Rear Camera Mirror ON/OFF

*Reverse Radar ON/OFF, Reverse Track ON/OFF

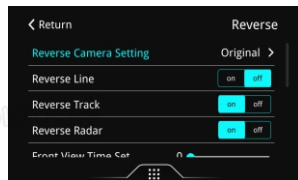
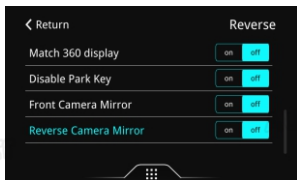

5. The up, down, left, and right positions of CarPlay and Android Auto images are not fully displayed.

You need to adjust the up, down, left, and right display. Find CarPlay and Android Auto in the settings and adjust the up, down, left, and right display data.

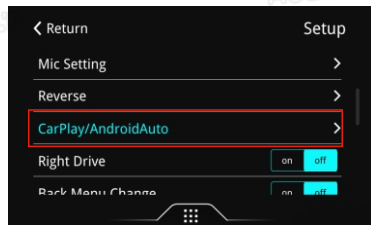

6. How to set CarPlay and Android Auto automatic night mode?

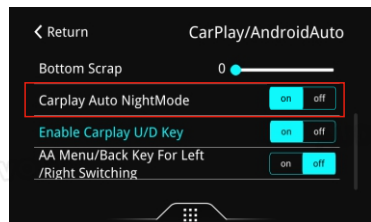

7. Solution to black screen after CarPlay or Android Auto is connected:

*Place the wifi antenna close to the phone. Do not stick it on metal.

*Change the Wifi Channel in the settings. You can choose signal channels such as 36, 149, and 6.

*Press the BACK button for 5 seconds to restart the system.

*Go to Settings-Bluetooth-Reset Bluetooth of the box.

*Go to Phone Settings-General-Restore-Restore Network Settings, and then restart the phone. Then re-pair CarPlay or Android Auto.

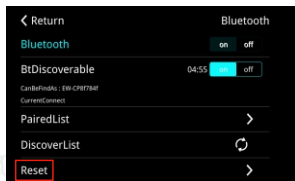
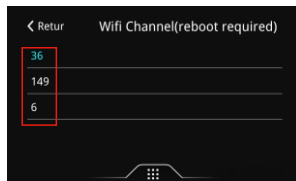

9. No sound when playing music or making calls after installing MMI BOX?

*Set AUX in the original car system, and disconnect the original car Bluetooth with the phone.

10.If the options cannot be saved after setting and the function is abnormal

you can restore the factory settings.

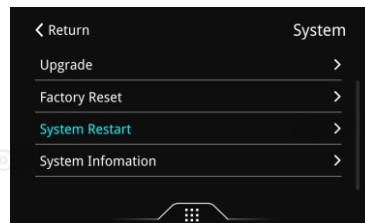

8. Audio settings

