

User Manual



AUDIOVOLT



Accessories

CIC System Product List



Power cable



LVDS cable



Wifi antenna



Microphone



Mic adapter cable



AV-USB cable

NBT System Product List



Power cable



LVDS cable

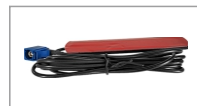

Wifi antenna



AV-USB cable

EVO System Product List



Power cable



LVDS cable



USB audio box



Wifi antenna



AV-USB cable

CIC wiring connections(Method 1 compatible models:F10 F11 F12 F01 F02 F25 E70 E71 F07)

OFF ON

1: ↓ 0: ↑

Screen size	DIP code setting
6.5 inches	00010000
8.8/10.25 inches	00110000

Note: If an external microphone is used, set DIP 7 to ON

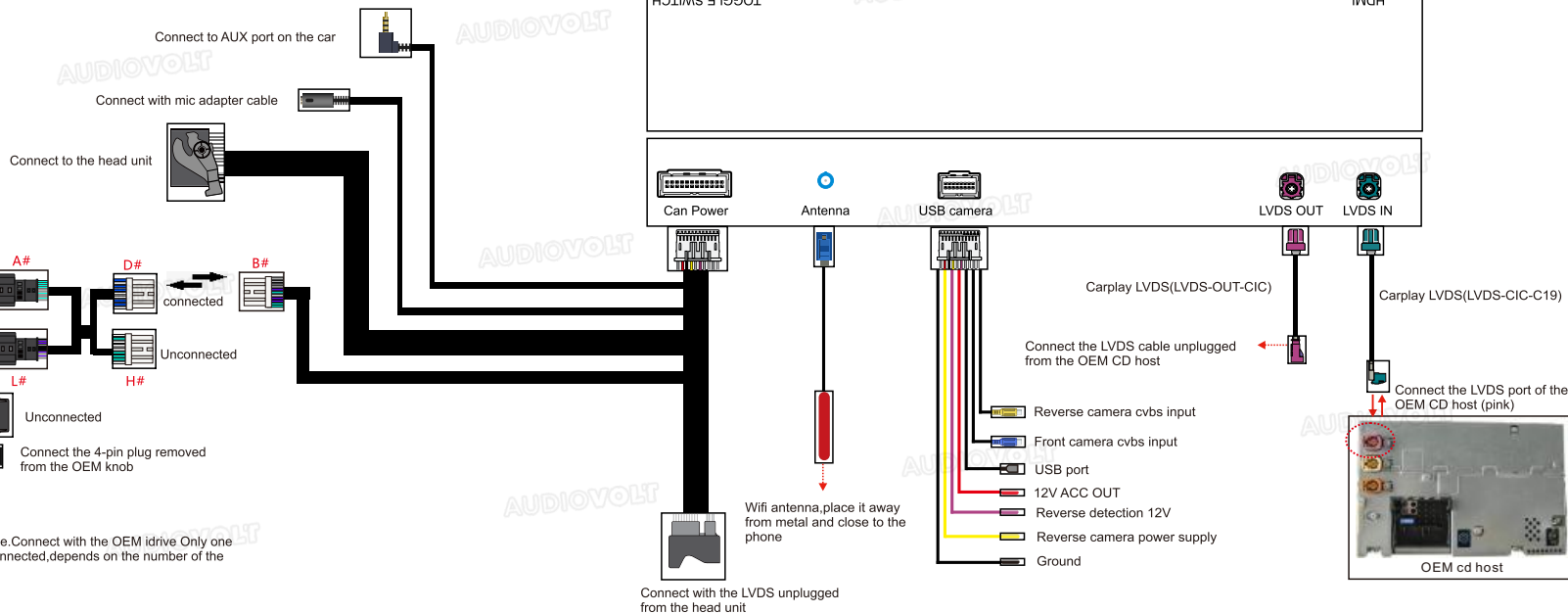
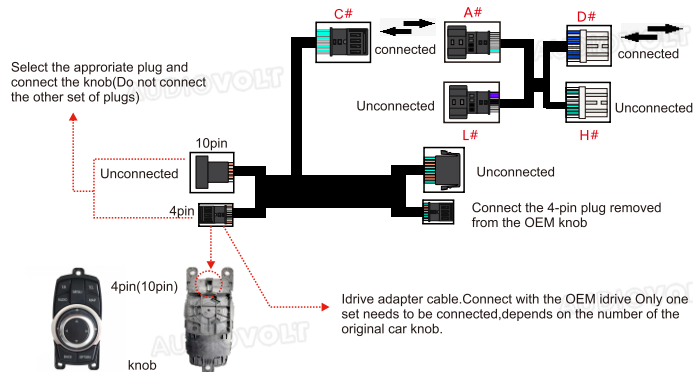

CIC wiring connections(Method 2 compatible models:E84 E87 E71 E90 E60 E89 E87 F25)

OFF

ON

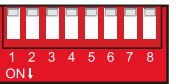

1: ↓

0: ↑

Screen size	DIP code setting
6.5 inches	00010000
8.8/10.25 inches	00110000

Note: If an external microphone is used, set DIP 7 to ON

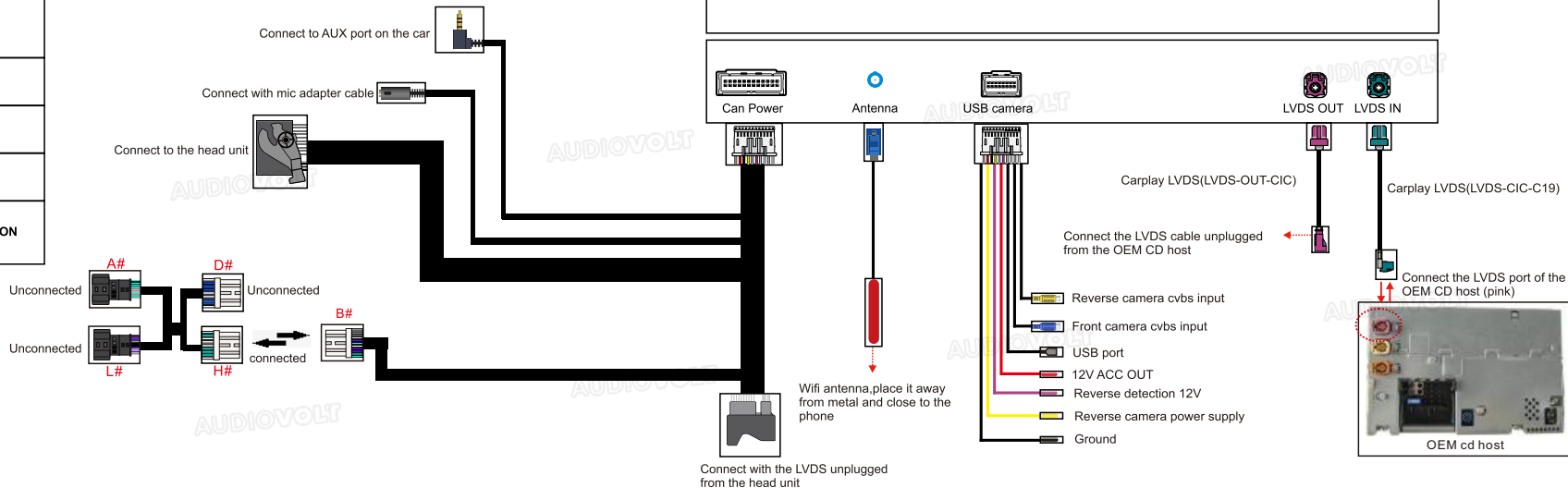

CIC wiring connections(Method 3 compatible models:F06 F12 F13 F01)

OFF
ON

1: ↓ 0: ↑

Screen size	DIP code setting
8.8/10.25 inches	11100000

Note: If an external microphone is used, set DIP 7 to ON

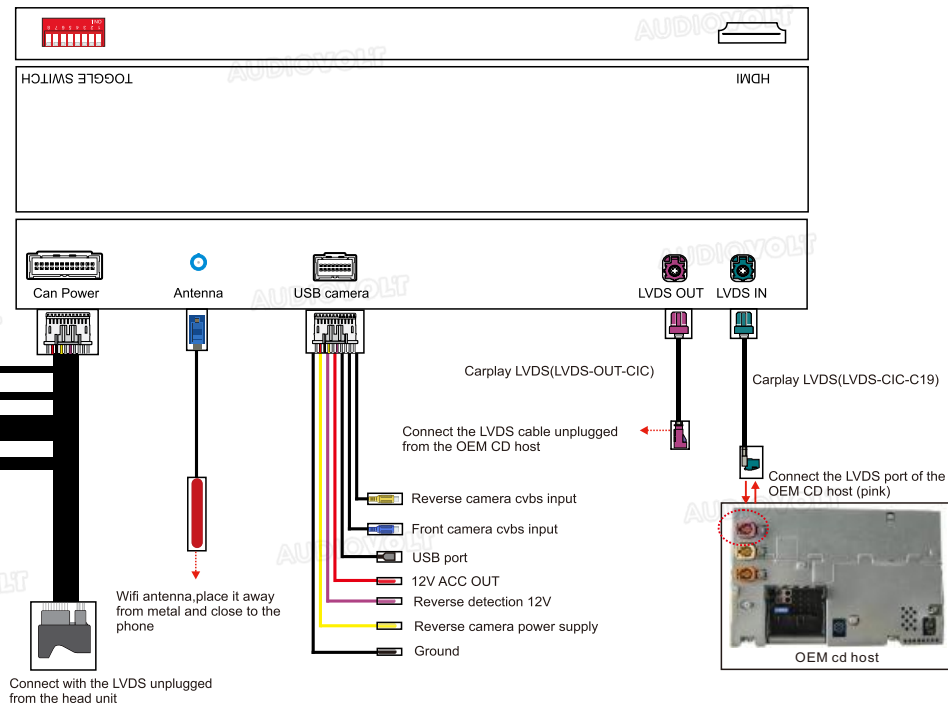
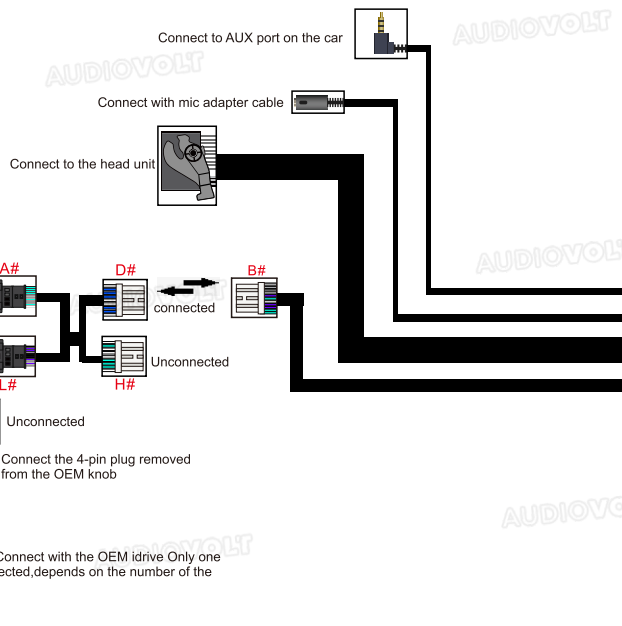
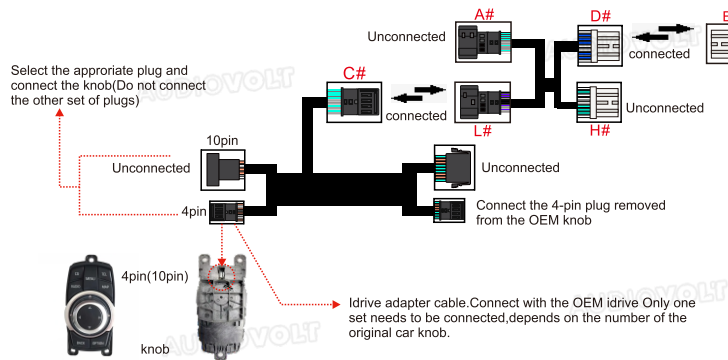

NBT wiring connections

Screen size	DIP code setting
6.5 inches	11000000
8.8/10.25 inches	11100000

Note: If an external microphone is used, set DIP 7 to ON

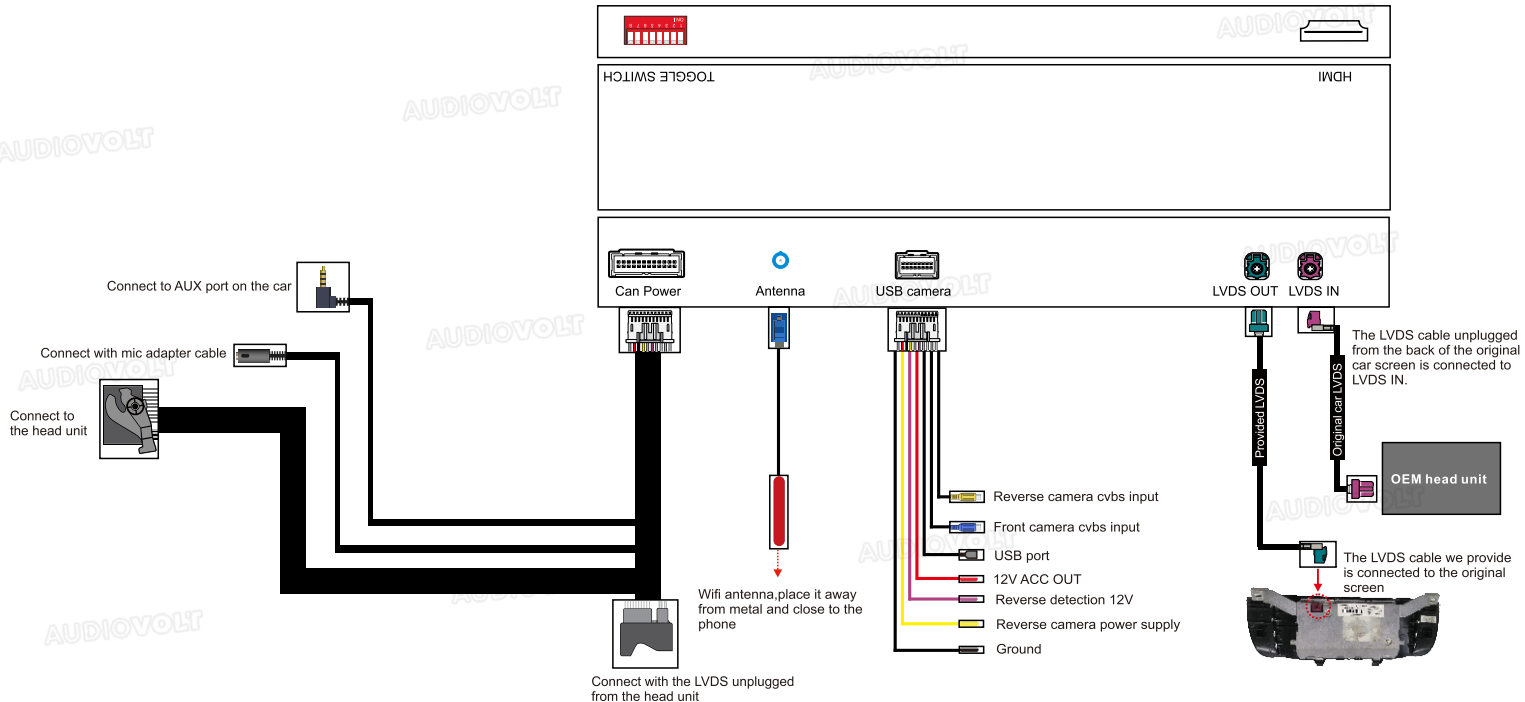

EVO wiring connections

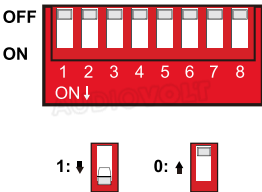

Screen size	DIP code setting
6.5 inches	11000000
8.8 inches	11100000
10.25 inches	11100000/11110000

Note: If an external microphone is used, set DIP 7 to ON

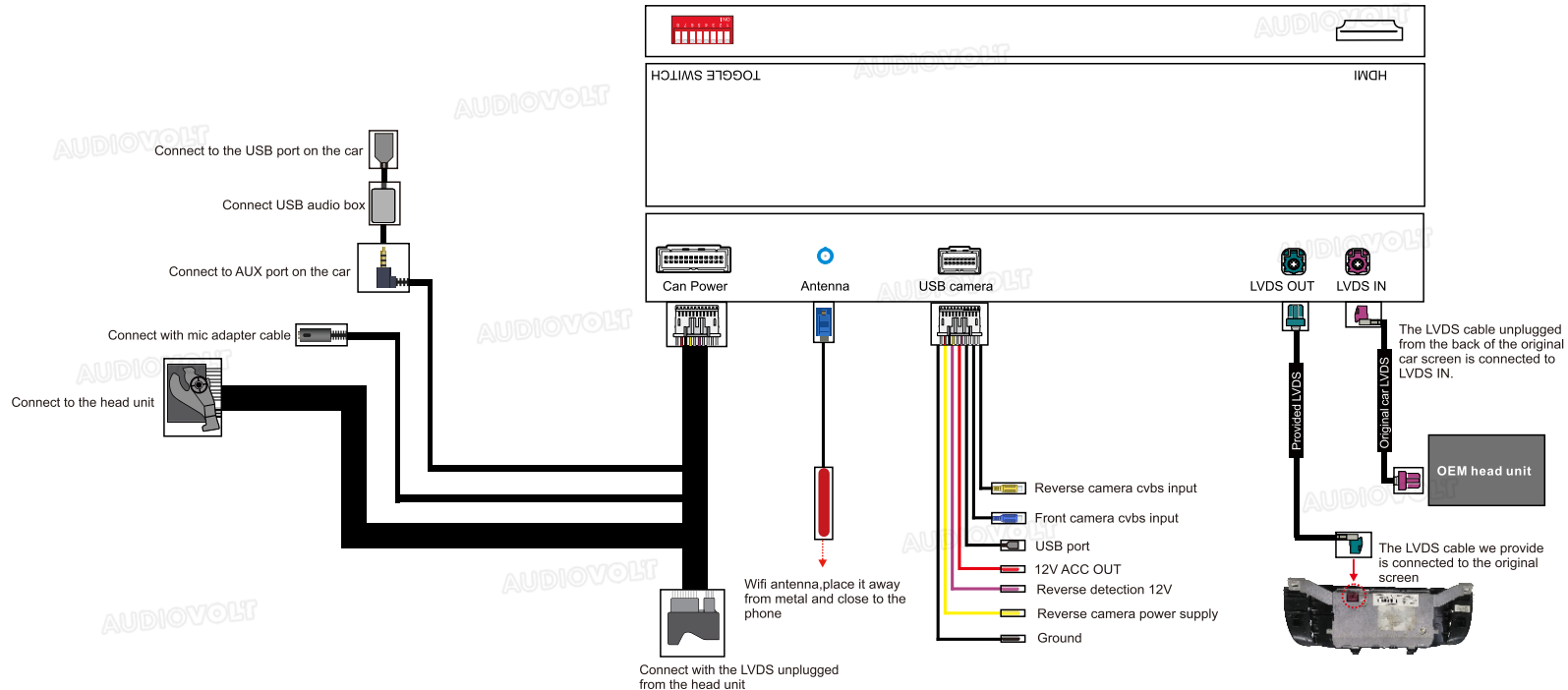

Original car button definition

1. MENU: Press and hold for 3s to switch system
2. Knob: Move the pointer
3. BACK: Short press to back to previous page/Press and hold on for 5s to restart the box
4. Volume adjustment: Decrease/increase the volume
5. Long press to activate voice control (Siri or Google Assistant)
6. Short press to answer the call, long press to hang up



Reverse camera connection

Automatic transmission

1. Connect the reverse camera to CVBS labeled 'Reverse camera'
2. Connect the cable labeled '12V Reverse camera' to camera power
3. Setting→Reverse→Reverse camera→Aftermarket

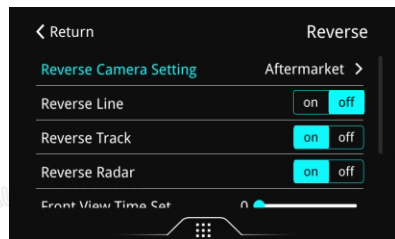

Manual transmission

1. Connect the reverse camera to CVBS labeled 'Reverse camera'
2. Connect the cable labeled 'Reverse 12V IN' to camera power
3. Setting→Reverse→Reverse camera→Aftermarket

Product features

1. Wireless Apple CarPlay/Android auto, pairing via Bluetooth, transfer via WIFI.
2. Support Airplay/Autolink
3. Work Wired CarPlay, turn off wifi at first, and connect via lighting cable (meanwhile wired keep your phone charged)
4. Enjoy your favorite videos and music.
5. Voice control by saying "Hey Siri..."
6. Aftermarket front/rear/360 camera input. (Support Dynamic guidance lines)
7. U-disk drive to play music and videos by connecting USB port from CarPlay kit
8. Support original BT to play sound and make phone call
9. Full OEM buttons control.
10. HDMI input, with HDMI device to get more high-definition video.

Product Description

1. Product Model: BMCP
2. Weight: 0.95 kg per box (including wire)
3. Product size: 14.8 cm x 9.3 cm x 2.4 cm

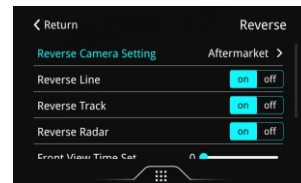

Wireless CarPlay

Wireless carplay and Android auto connection steps

1. Turn on the Bluetooth visible option in the settings.
2. Return to the system main interface and click the CarPlay icon.
3. Turn on the wifi and Bluetooth options in the phone settings. Use the phone to search for the Bluetooth name EW-XXXX.
4. Click Pairing-Allow-Use carplay on the phone. The system will automatically connect successfully.

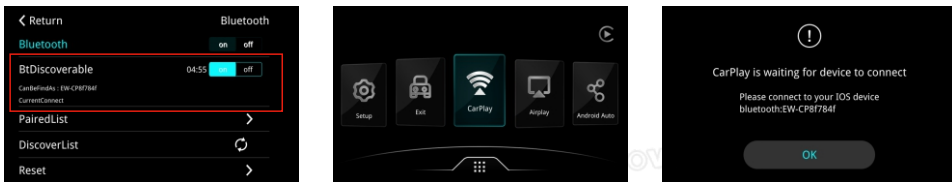

If wireless carplay cannot be connected:

1. Click on the carplay Bluetooth (EW-CPXXX) and wifi on the phone to reconnect
2. Clear the Bluetooth devices on the phone and the car, and then pair and connect,
3. Restore the mobile network on the phone
4. Check whether CarPlay on your phone is turned on. (Settings - Screen Usage Time - Content and Privacy Access Permissions - Allowed APP)
5. Turn on all Siri permissions
6. If necessary, check whether the two antenna is installed correctly (keep away from metal)

Wireless CarPlay disconnection method:

1. Disconnect the Bluetooth connection between the phone and the box.
2. Turn off wifi in the phone settings

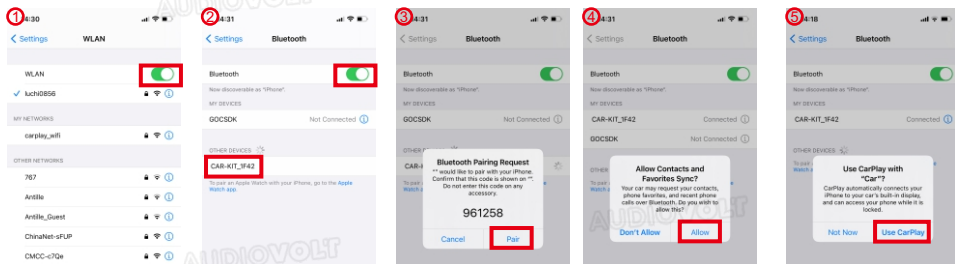

Wireless Android Auto

- (1) Turn on the CarPlay MMI, select Bluetooth in the system [Settings], and make the Bluetooth visible.
- (2) Return to the system's main interface and click the [Android Auto] icon.
- (3) Ensure the phone's Bluetooth, Wi-Fi, and location services are turned on during the setup. Then, go to [Settings] > [Bluetooth] on the phone, search for the Bluetooth name (EW-CPXXX), and click to pair.
- (4) After the phone successfully pairs with the vehicle via Bluetooth, Android Auto will start within a few seconds. If it does not start automatically, follow the prompts on the screen to launch Android Auto. Note: You may need to tap the Android Auto icon on the vehicle screen.

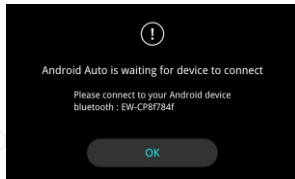
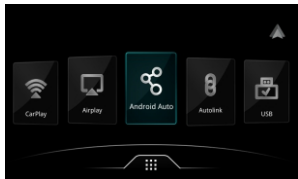
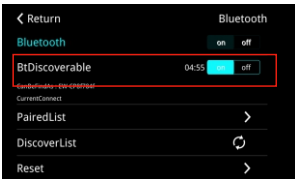

Wireless Airplay

Please note: Disconnect the Bluetooth and WiFi connections of CarPlay before connecting.

- (1) Click the **[AirPlay]** icon in the main menu.
- (2) On your mobile phone, find the corresponding SSID in WiFi settings (e.g., EW-CPXXXX) and enter the password 88888888.
- (3) Bring up the phone's menu bar, select Screen Mirroring from the menu options, and then click AirPlay to complete the mirroring.

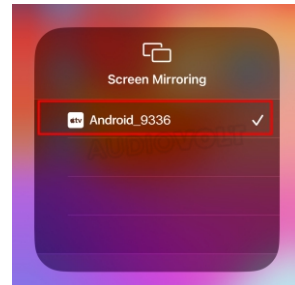
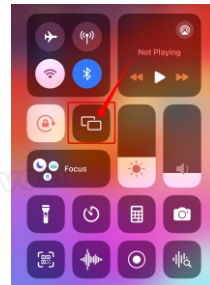
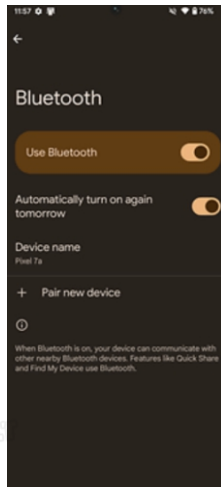
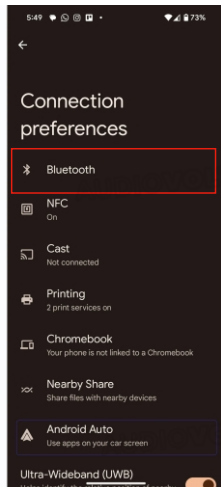
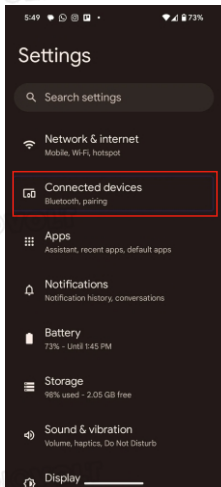
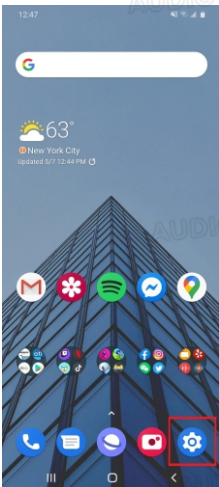
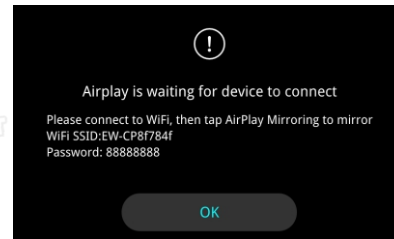
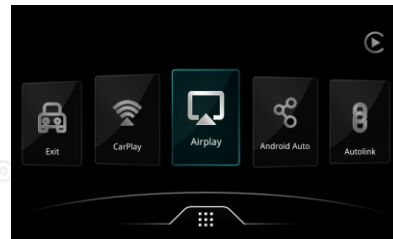

Wired Autolink

(1)Click the **[Autolink]** icon on the screen and select "Confirm."

(2)Connect the mobile phone to the USB port of the MMI box via a data cable. The mobile phone will prompt you to enter the browser to download and install the "Autolink APP."

(3)Reopen the Autolink APP on the mobile phone and unplug the data cable.

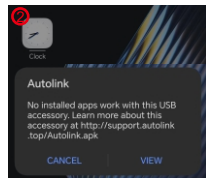
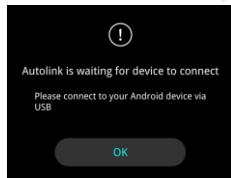
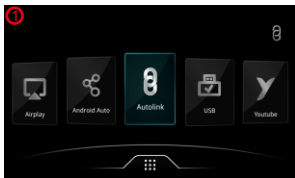

YouTube

(1)Click the **[YouTube]** icon on the screen to enter the program.

(2)Turn on the mobile phone hotspot. Search for the phone's Wi-Fi name on the car screen and enter the password.

(3)Wait for YouTube to connect successfully.

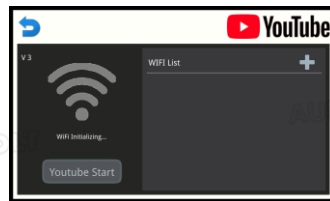
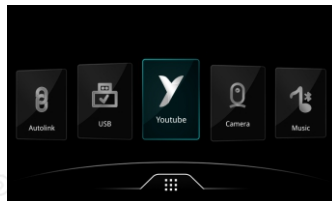

Bluetooth music and Bluetooth phone function

Make sure the phone is disconnected from the wireless Carplay/Android Auto, then connect the box's Bluetooth, and then click the Bluetooth music or Bluetooth phone icon to use these two functions

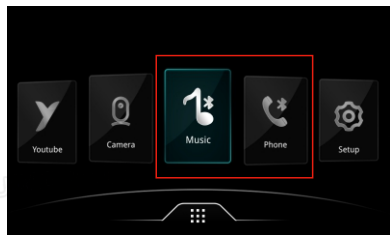

USB Music & HD Video Playback

1. Insert the USB with video and music files first, click the **[USB]** icon

2. Switch between music and video functions, click the three dots in the upper right corner to select audio or video function

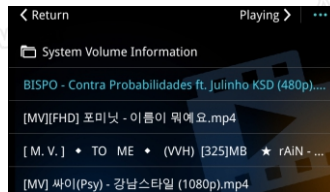
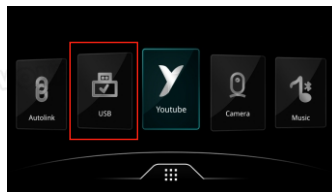

Frequently Asked Questions(FAQ)

1. How to set the language?

Enter the [Setup] icon. Select the language option. Set the corresponding language.

MMI box supported languages: Chinese, English, Italian, Polish, Spanish, Turkish, French, Korean, Portuguese, German

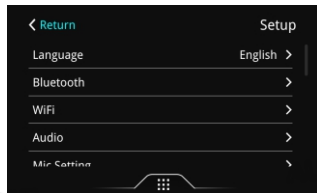
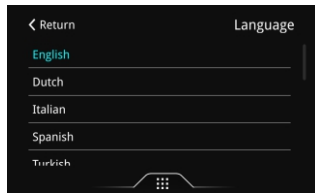
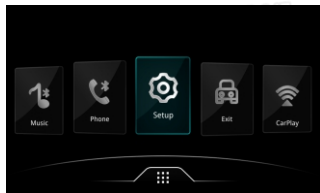

2. How to use the original Bluetooth channel function?

1. Turn on setting [Use original car's BT channel]
2. Search and connect original car's BT on phone first
3. Search and connect carplay's BT 'EW-CPXXX'
4. Select Bluetooth audio output in the original system. Carplay will play music and navigation sounds.

The screen mirroring and USB audio and video functions cannot be output when using the original car Bluetooth.

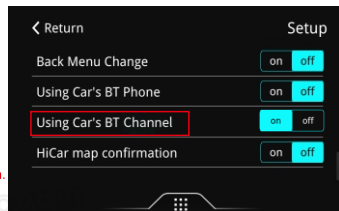

3. How to set the Reverse option

Automatic transmission:

- (1) Attach the reverse camera to the CVBS port labeled "Reverse Camera."
- (2) Connect the yellow cable labeled "12V Reverse Camera" to camera's power supply..
- (3) Navigate to Settings > Reverse > Reverse Camera > Aftermarket.
- (4) Ensure the camera option is set to Aftermarket. In the reverse camera settings, set the Reverse Line to OFF. All other options should remain at their default settings.

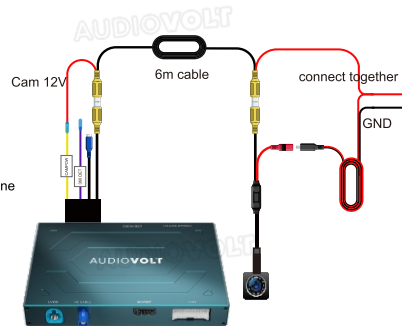
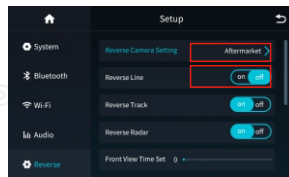

Manual transmission

- (1) Connect the reversing camera to the CVBS "Reversing Camera."
- (2) Connect the purple cable labeled "Reversing Detection 12V" to the camera's power supply.
- (3) Click Settings > Reversing > Reversing Camera > Aftermarket
- (4) Set the camera option to "Aftermarket". Ensure the reverse line is set to "ON".
- (5) Connect the rear-view camera's power wire to the "12V" power supply of the reverse light

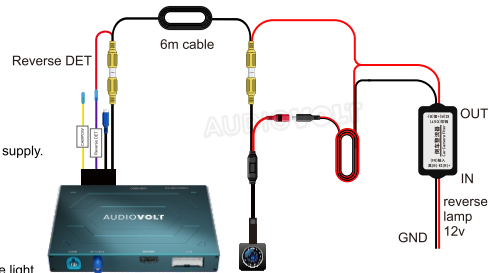

(Rectifier version)

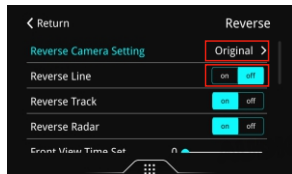
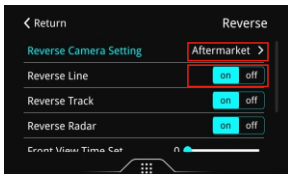

*For vehicles equipped with an original camera, select the camera option "Original" and ensure the reverse wire option is set to "OFF" .

All Other options remain unchanged.

4. Reversing option function description

*You can choose the front camera display time from 0~15s.

*If the vehicle is equipped with an aftermarket 360 camera (not the original 360 camera).

You need to set the matching 360 camera to ON in the reversing settings.

*Front Camera mirror ON/OFF

*Rear Camera mirror ON/OFF

*Reverse Radar ON/OFF, Reverse Track ON/OFF

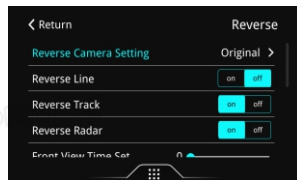
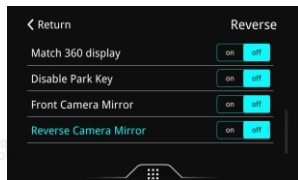
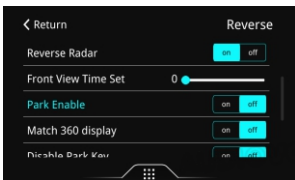

5. The up, down, left, and right positions of CarPlay and Android Auto images are not fully displayed.

You need to adjust the up, down, left, and right display. Find carplay and Android Auto in the settings and adjust the up, down, left, and right display data.

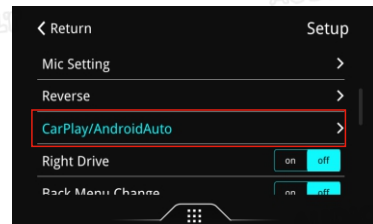

6. How to set CarPlay and Android Auto automatic night mode?

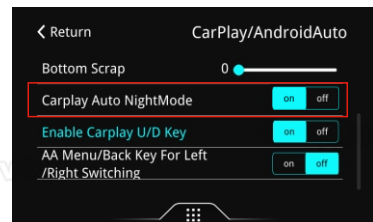

7. Solution to black screen after CarPlay or Android Auto is connected:

*Place the wifi antenna close to the phone. Do not stick it on metal.

*Change the wifi channel in the settings. You can choose signal channels such as 36, 149, and 6.

*Press the BACK button for 5 seconds to restart the system.

*Go to Settings-Bluetooth-Reset Bluetooth of the box.

*Go to Phone Settings-General-Restore-Restore Network Settings, and then restart the phone. Then re-pair CarPlay or Android Auto.

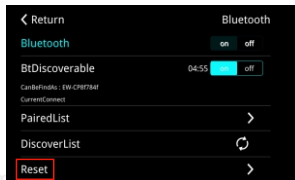
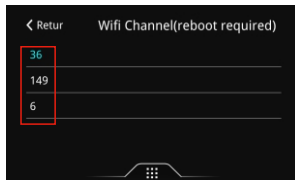
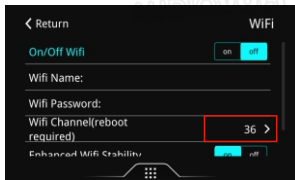

8. Audio settings

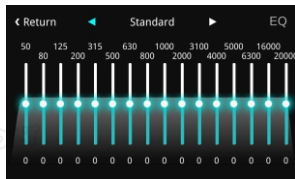
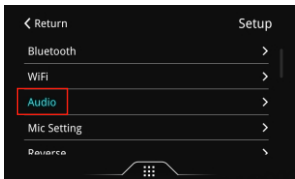

9. No sound when playing music or making calls after installing MMI BOX?

*Set AUX in the original car system, and disconnect the original car Bluetooth with the phone.

10. How to fix the problem of system restarting when pressing the menu button?

Find the menu button and BACK function change option in the settings and set it to OFF.

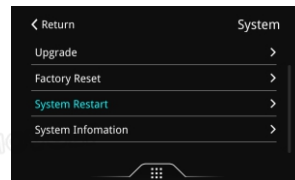
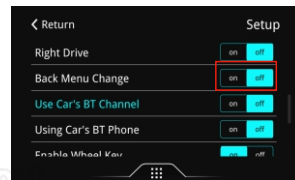

11. If the options cannot be saved after setting and the function is abnormal

you can restore the factory settings.

12. If the original vehicle information cannot be displayed and the time cannot be saved

It is necessary to check whether the optical fiber line is transferred to our power cord plug.

