

# User Manual



AUDIOVOLT



## Product features

1. Wireless Apple CarPlay/Android auto, pairing via Bluetooth, transfer via WIFI.
2. Support Airplay/Autolink
3. Work Wired CarPlay, turn off wifi at first, and connect via lighting cable (meanwhile wired keep your phone charged)
4. Enjoy your favorite videos and music.
5. Voice control by saying "Hey Siri..."
6. Aftermarket front/rear/360 camera input. (Support Dynamic guidance lines)
7. U-disk to play music and videos by connecting USB port from CarPlay kit
8. Support original BT to play sound and make phone call
9. Full OEM buttons control.
- 10.HDMI input, with HDMI device to get more high-definition video.

## Product Description

- 1.Product Model:LR    2.Weight:0.95 kg per box(including wire)    3.Product size:14.8 cm x 9.3 cm x 2.4 cm

## Accessories



Power cable

LVDS cable

LVDS cable

Wifi antenna

USB cable

USB AUX Audio Box  
(Optional)

## Compatible models

Model	Year	Dip Switch	Cable
Discover	2017-2019	8 inch Dip switch: All off 10.25 inch Dip switch: 5 ON Note: Install microphone:Dial 7 set to ON	8 inch: XCAN-GPLRHI-L-V2 (Power cord- Big plug) LVDS-CPBMW1901-NBT-S (Lvds cable) LVDS-EVO-EXTEND (Extension of lvds cable) AV-USB-CPBHW-CIC-V2 (USB cable) HX-TO3C-FAKRA1500(Antenna)  10.25 inch: XCAN-GPLRHI-H-V2 (Power cord- Flat plug) LVDS-CPBMW1901-NBT-S (Lvds Cable) LVDS-EVO-EXTEND (Extension of lvds cable) AV-USB-CPBHW-CIC-V2 (USB cable) HX-TO3C-FAKRA1500 (Antenna) <b>Note: Jaguar F TYPE/XJ/XJL three 8-inch screens also use 10.25-inch screen cable</b>
Range Rover Sport	2017		
Range Rover	2017		
Range Rover Evoque	2016-2018		
Discover Sport	2017		
Jaguar XF	2016-2018		
Jaguar XJ	2016-2018		
Jaguar XE	2015-2018		
Jaguar F-TYPE	2016-2019		
Jaguar F-PACE	2016-2018		
Jaguar E-PACE	2017-2018		



**Distinguish the Harman system: Time is in the middle, as shown in the picture**

The host of Harman Systems the time is shown in the middle

## Wiring diagram of Haman (8 inch)

AUDIOVOLT

OFF  
ON

1 2 3 4 5 6 7 8  
ON ↓

0: ↑    1: ↓

Screen size	DIP code setting
8 inch	00000000

Note: 1.You must remove the power cable from the box before set the DIP switch  
2.Add MIC:7 ON

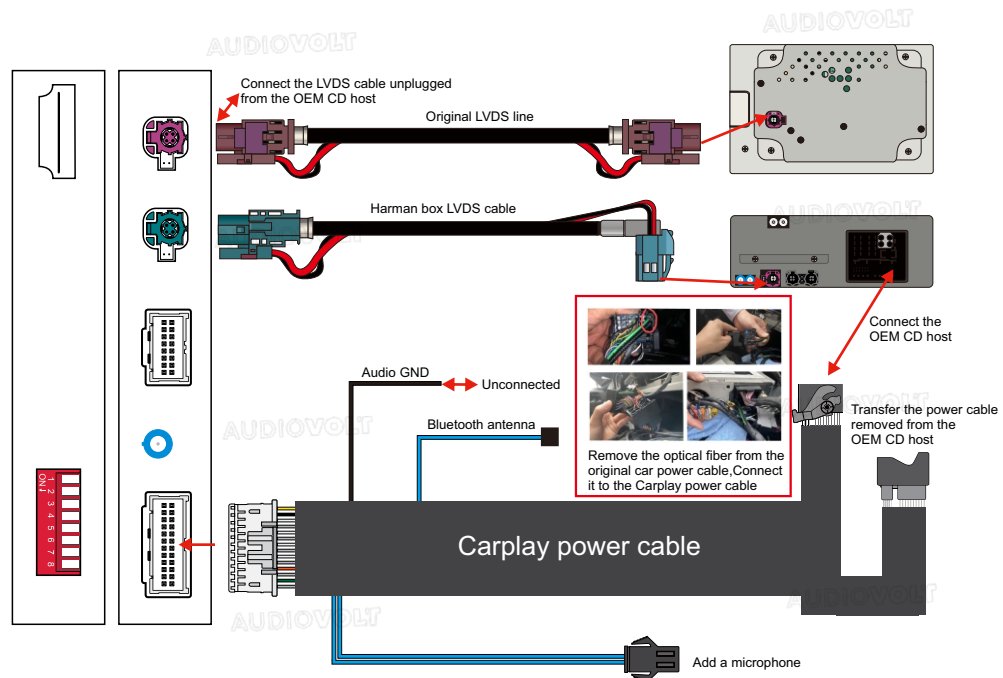
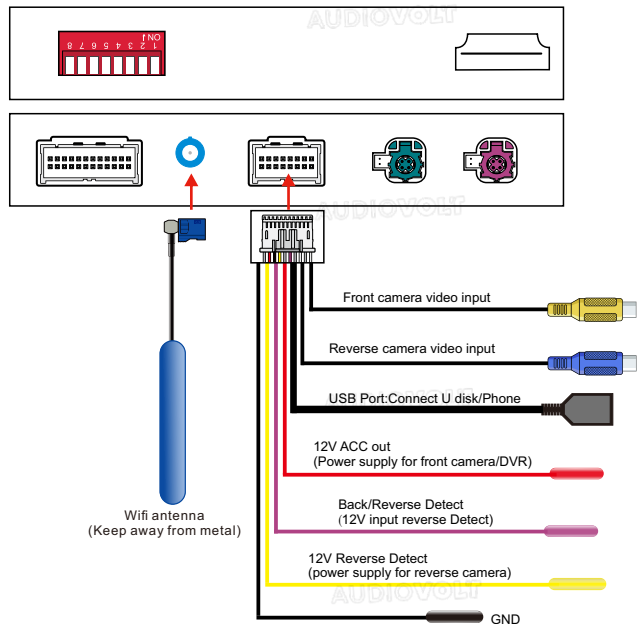

## Wiring diagram of Haman (10.25 inch)

**AUDIOVOLT**

OFF ON

1 2 3 4 5 6 7 8

ON ↓

0: ↑ 1: ↓

Screen size	DIP code setting
10.25 inch	00001000

**Note:** 1.You must remove the power cable from the box before set the DIP switch  
2.Add MIC:7 ON

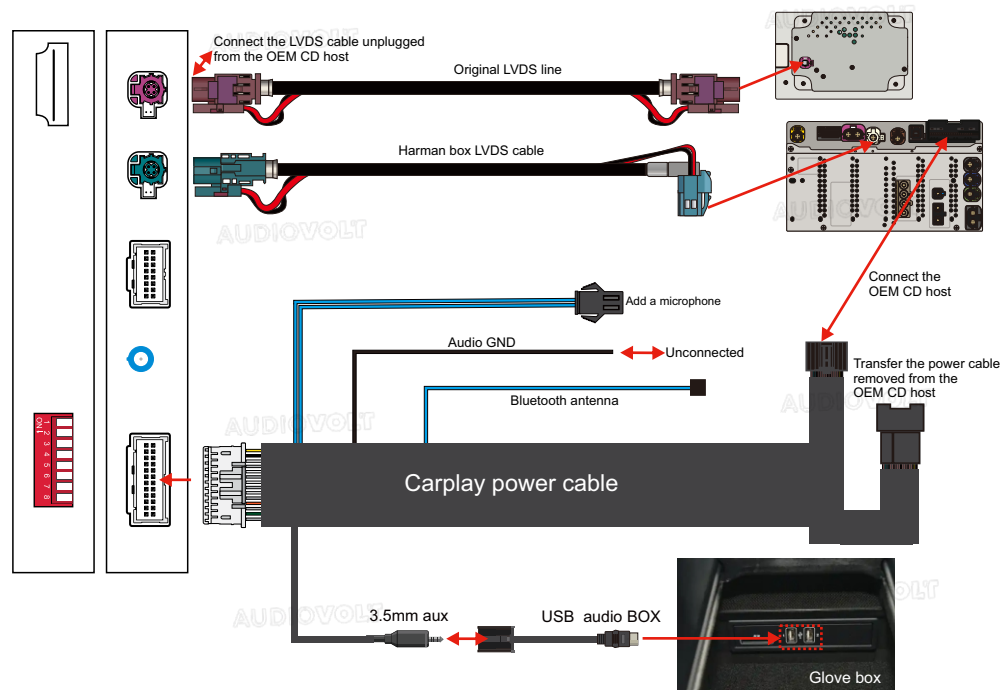
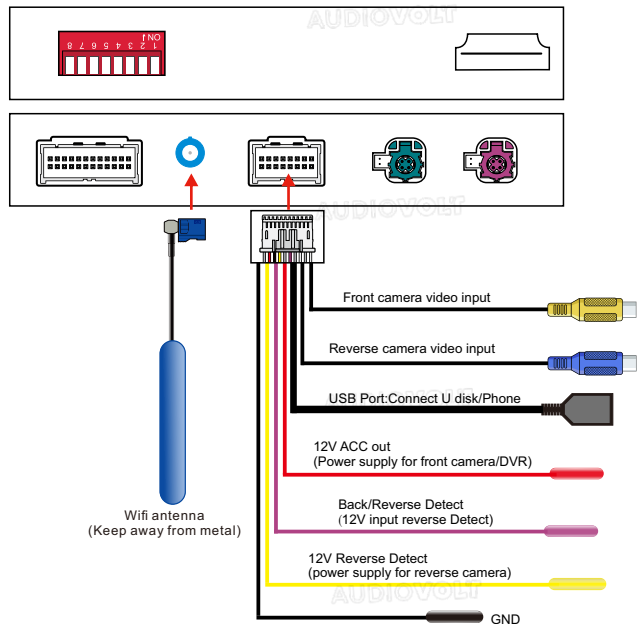



1.Short press:  
Return to the previous level

2.Press and hold for 10 seconds:  
Reset box

Press and hold for 3seconds:  
Enter the box system/  
Return to car

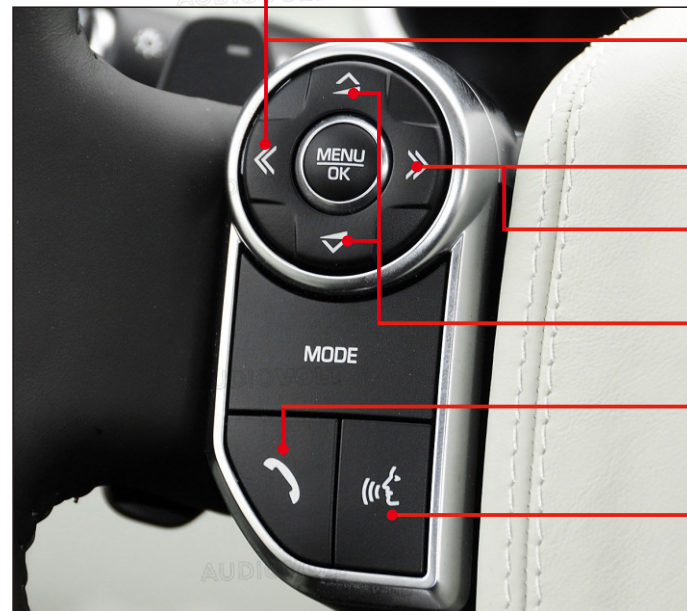

Short press:Previous song

Press and hold for 3seconds:  
Enter the box system/Return to car

Short press:Next song

Press and hold for 3seconds:  
Enter the box system/Return to car

Control system volume

Press and hold for 3:  
Answer calls or hang up

Press and hold for 3 seconds:  
Wake up voice

## Wireless CarPlay connection steps

1. Turn on the Bluetooth visible option in the settings.
2. Return to the system main interface and click the CarPlay icon.
3. Turn on the wifi and Bluetooth options in the phone settings. Use the phone to search for the Bluetooth name EW-XXXX.
4. Click Pairing-Allow-Use carplay on the phone. The system will automatically connect successfully.

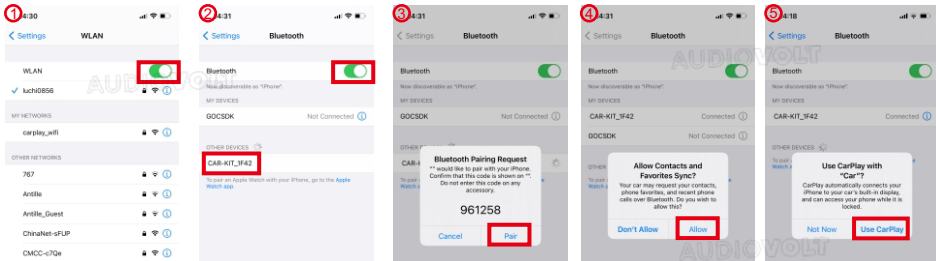
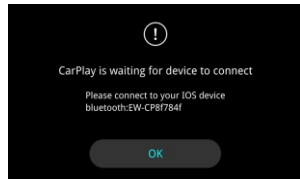
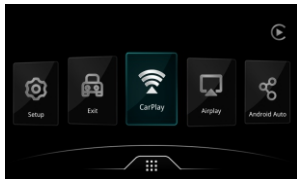
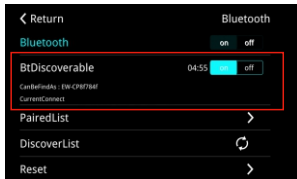

If wireless carplay cannot be connected:

1. Click on the carplay Bluetooth (EW-CPXXXX) and wifi on the phone to reconnect
2. Clear the Bluetooth devices on the phone and the car, and then pair and connect,
3. Restore the mobile network on the phone
4. Check whether CarPlay on your phone is turned on. (Settings - Screen Usage Time - Content and Privacy Access Permissions - Allowed APP)
5. Turn on all Siri permissions
6. If necessary, check whether the wifi antenna is installed correctly (keep away from metal)

## Wireless CarPlay disconnection method:

1. Disconnect the Bluetooth connection between the phone and the box.
2. Turn off wifi in the phone settings

## Wireless Airplay

**Please note:** Disconnect the Bluetooth and WiFi connections of CarPlay before connecting.

- (1) Click the [AirPlay] icon in the main menu.
- (2) On your mobile phone, find the corresponding SSID in WiFi settings (e.g., EW-CPXXXX) and enter the password 88888888.
- (3) Bring up the phone's menu bar, select Screen Mirroring from the menu options, and then click AirPlay to complete the mirroring.

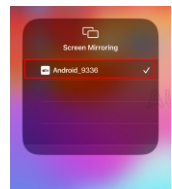
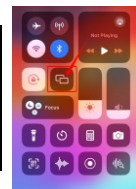
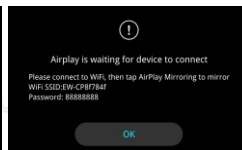
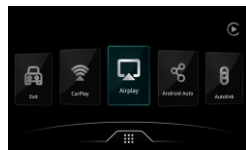

## Wireless Android Auto connection steps

- (1) Turn on the CarPlay MMI, select Bluetooth in the system [Settings], and make the Bluetooth visible.
- (2) Return to the system's main interface and click the [Android Auto] icon.
- (3) Ensure the phone's Bluetooth, Wi-Fi, and location services are turned on during the setup. Then, go to [Settings] > [Bluetooth] on the phone, search for the Bluetooth name (EW-CPXXX), and click to pair.
- (4) After the phone successfully pairs with the vehicle via Bluetooth, Android Auto will start within a few seconds. If it does not start automatically, follow the prompts on the screen to launch Android Auto. Note: You may need to tap the Android Auto icon on the vehicle screen.

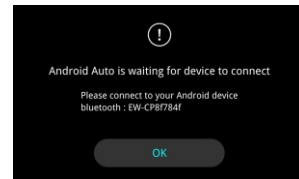
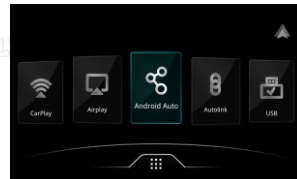
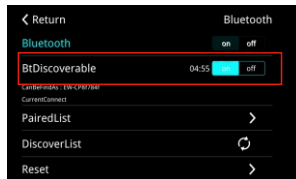
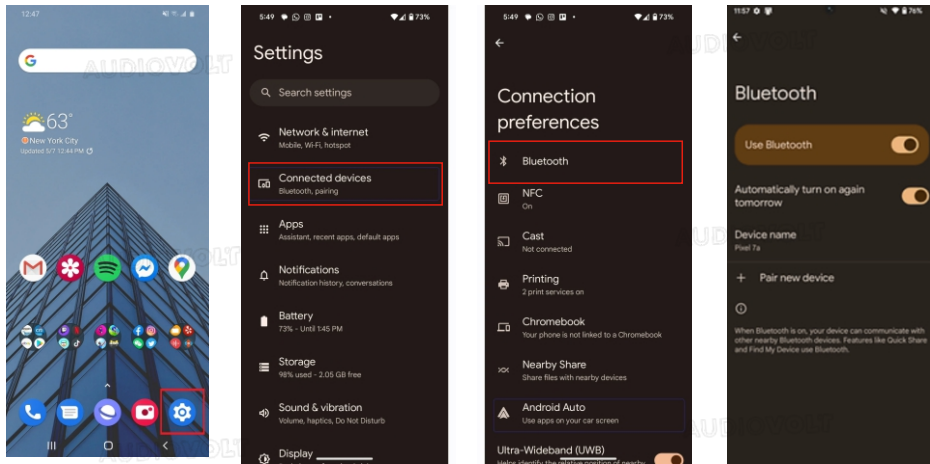

## Wired Autolink

- (1) Click the [Autolink] icon on the screen and select "Confirm."
- (2) Connect the mobile phone to the USB port of the MMI box via a data cable. The mobile phone will prompt you to enter the browser to download and install the "Autolink APP."
- (3) Reopen the Autolink APP on the mobile phone and unplug the data cable.

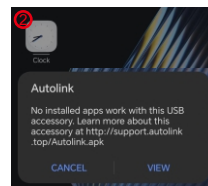
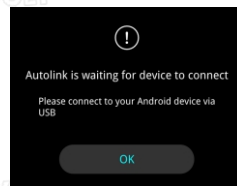
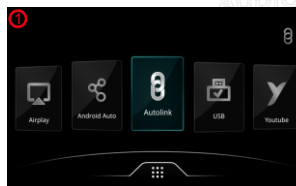

## Bluetooth music and Bluetooth phone function

Make sure the phone is disconnected from the wireless Carplay/Android Auto, then connect the box's Bluetooth, and then click the Bluetooth music or Bluetooth phone icon to use these two functions

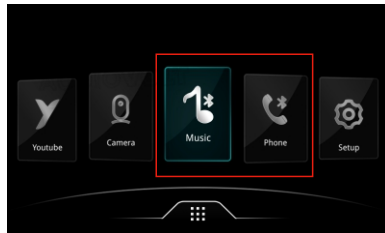

## YouTube

- (1) Click the **[YouTube]** icon on the screen to enter the program.
- (2) Turn on the mobile phone hotspot. Search for the phone's Wi-Fi name on the car screen and enter the password.
- (3) Wait for YouTube to connect successfully.

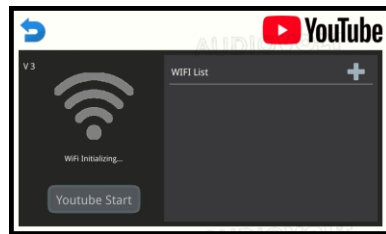
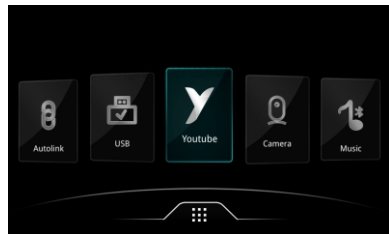

## USB Music & HD Video Playback

1. Insert the USB with video and music files first, click the **[USB]** icon
2. Switch between music and video functions, click the three dots in the upper right corner to select audio or video function

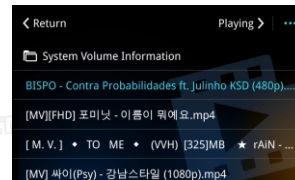
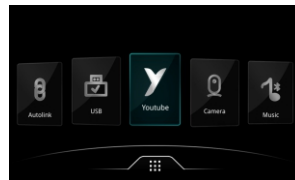

## Frequently Asked Questions(FAQ)

### 1. How to set the language?

Enter the **[Setup]** icon. Select the language option. Set the corresponding language.

MMI box supported languages: Chinese, English, Italian, Polish, Spanish, Turkish, French, Korean, Portuguese, German

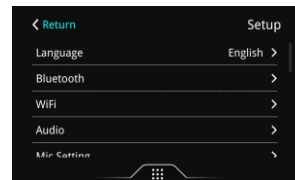
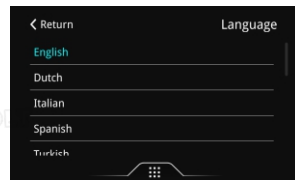
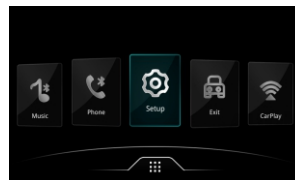

## 2. How to use the original Bluetooth channel function?

1. Turn on setting [Use original car's BT channel]
2. Search and connect original car's BT on phone first
3. Search and connect carplay's BT 'EW-CPXXX'
4. Select Bluetooth audio output in the original system. Carplay will play music and navigation sounds.

The screen mirroring and USB audio and video functions cannot be output when using the original car Bluetooth.

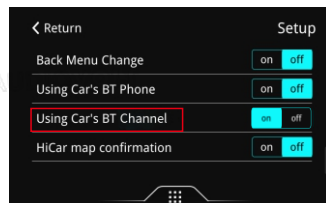

## 3. How to set the Reverse option

### Automatic transmission:

- (1) Attach the reverse camera to the CVBS port labeled "Reverse Camera."
- (2) Connect the yellow cable labeled "12V Reverse Camera" to camera's power supply..
- (3) Navigate to Settings > Reverse > Reverse Camera > Aftermarket.
- (4) Ensure the camera option is set to Aftermarket. In the reverse camera settings, set the Reverse Line to OFF. All other options should remain at their default settings.

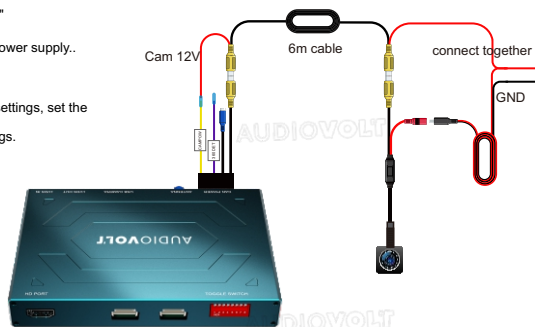
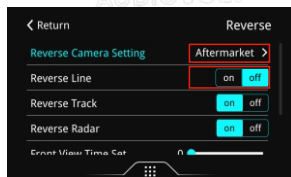

### Manual transmission

- (1) Connect the reversing camera to the CVBS "Reversing Camera."
- (2) Connect the purple cable labeled "Reversing Detection 12V" to the camera's power supply.
- (3) Click Settings > Reversing > Reversing Camera > Aftermarket
- (4) Set the camera option to "Aftermarket". Ensure the reverse line is set to "ON". Other options remain unchanged.
- (5) Connect the rear-view camera's power wire to the "12V" power supply of the reverse light

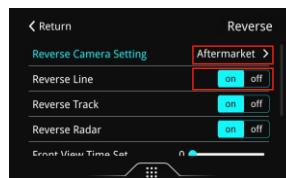

\*For vehicles equipped with an original camera, select the camera option "Original" and ensure the reverse wire option is set to "OFF" .

All Other options remain unchanged.

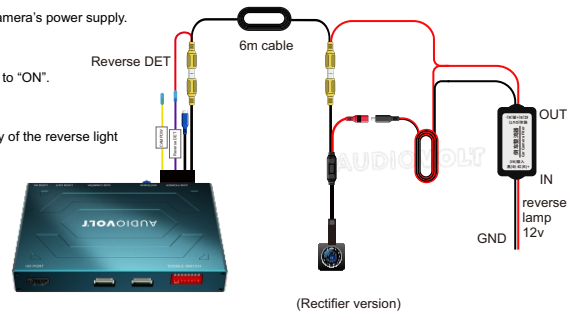

#### 4. Reversing option function description

\*You can choose the front camera display time from 0~15s.

\*If the vehicle is equipped with an aftermarket 360 camera (not the original 360 camera).

You need to set the matching 360 camera to ON in the reversing settings.

\*Front Camera Mirror ON/OFF

\*Rear Camera Mirror ON/OFF

\*Reverse Radar ON/OFF, Reverse Track ON/OFF

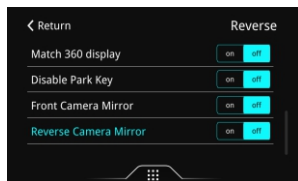
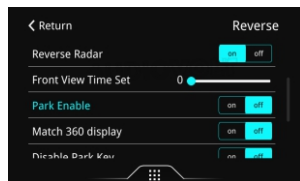

#### 5. The up, down, left, and right positions of CarPlay and Android Auto images are not fully displayed.

You need to adjust the up, down, left, and right display. Find CarPlay and Android Auto in the settings and adjust the up, down, left, and right display data.

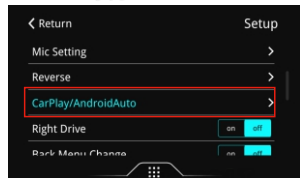

#### 6. How to set CarPlay and Android Auto automatic night mode?

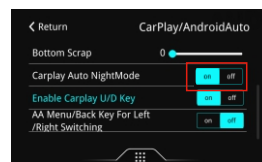

#### 7. How to set the steering wheel button swap?

If the steering wheel button does not work properly, need to set the steering wheel button function.

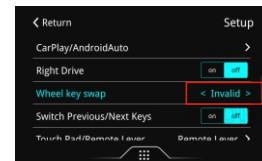
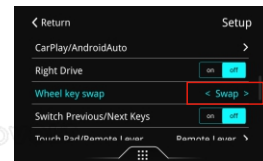
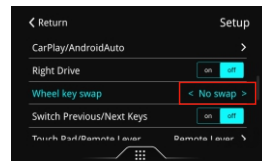

#### 8. Solution to black screen after CarPlay or Android Auto is connected:

\*Place the wifi antenna close to the phone. Do not stick it on metal.

\*Change the Wifi Channel in the settings. You can choose signal channels such as 36, 169, and 6.

\*Press the BACK button for 5 seconds to restart the system.

\*Go to Settings-Bluetooth-Reset Bluetooth of the box.

\*Go to Phone Settings-General-Restore-Restore Network Settings, and then restart the phone. Then re-pair CarPlay or Android Auto.

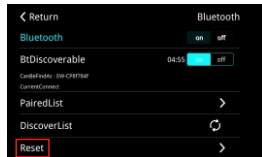
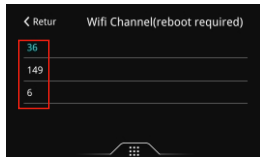
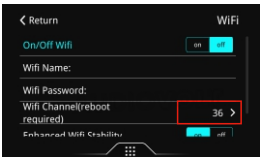

### 9. No sound when playing music or making calls after installing MMI BOX?

\*Set AUX in the original car system, and disconnect the original car Bluetooth with the phone.

### 10. Audio settings

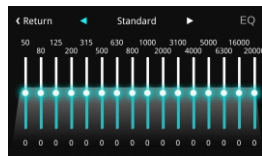
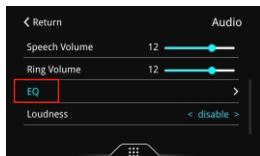
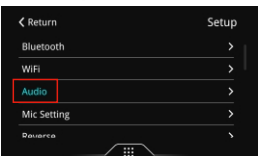

### 11. The options cannot be saved after setting. The function is abnormal. Can restore factory settings.

