

User Manual



AUDIOVOLT



Features

Long Press specific button to switch to iManAuto system main menu as picture

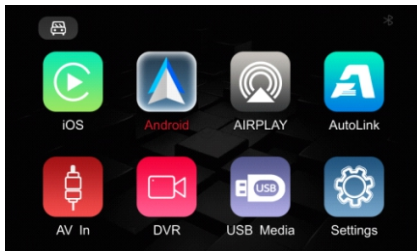

*Wired/Wireless CarPlay

*Wired/Wireless Android AUTO

*Screen casting function(Apple, Android)

*USB multimedia playback(support lossless audio, 720P video and picture playback)

*Support original rear view,aftermarket rear view, (CVBS/AHD), front view(Support setting time delay) or DVR

*Support the expansion of the addition of 360 panoramic view(CVBS/AHD)

*Support audio EQ adjustment, music navigation volume adjustment separately

*Support the original MIC(reserved for retrofitting MIC), support the call elimination echo automatic correction function.

*Support the original car Bluetooth call function

*Support AUX IN function and expandable digital TV

*Support wired BaiDu Car Life(need factory setting to open, password(0301)

Accessories



Power cable



LVDS cable



WIFI cable



USB cable

Connection method

Wireless CarPlay connection for the first time as follows (manual method):

Enter the wireless CarPlay settings and click on"Discover and connect devices"to bring up CX_BT As shown below

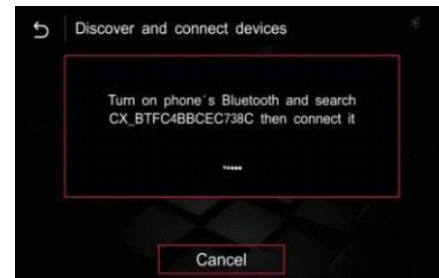
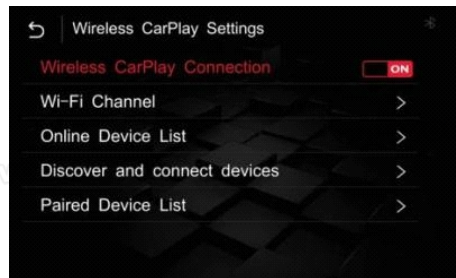

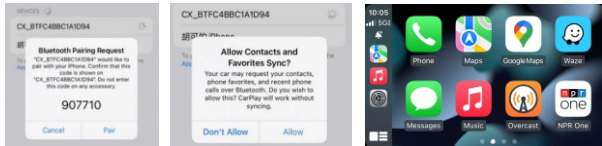

Turn on the Bluetooth function on your iPhone as shown above and search for the name CX_BT..., click connect and pair, then click use carplay

When you enter the interface, the wireless CarPlay will be connected successfully.

Note: (When connecting for the first time, manually complete the Bluetooth pairing of your iPhone. When the WIFI on your iPhone is turned on, the wireless CarPlay connection can be completed). And then the next time you start the car, it will automatically connect.

*Simple first-time wireless CarPlay connection method: First make a wired connection via USB, then enable wireless CarPlay on the phone according to the prompts, and the wireless connection will automatically connect after 15 seconds of unplugging the data cable.

The first-time wireless CarPlay connection is as follows (manual method):

Enter the settings - the wireless Android Auto settings, click pairing and the CX-BT... will pop up, as shown in the picture

Connect CX_BT...with Android phone Bluetooth receiver and search. After successful pairing, you will enter the AUTO interface as below:

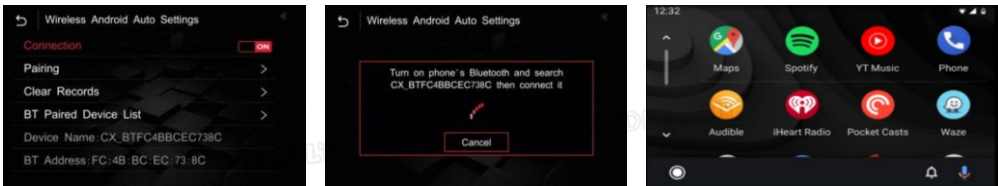

When you enter the interface, the wireless AUTO will be connected successfully.

*Simple first-time wireless AUTO connection method: First make a wired connection via USB, then connect AUTO according to your phone's prompts, and the wireless AUTO will automatically connect after 15 seconds of unplugging the data cable.

USB flash play

Insert the U disk will automatically jump to the USB interface, support audio, 720P video.

System Settings

Echo Settings:

*Anti-echo processing method: If there is an echo in the call, you can do the echo elimination process as shown, and then confirm the call echo problem.

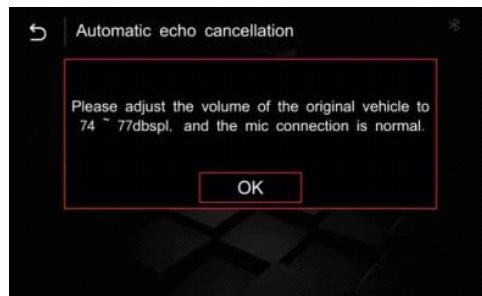
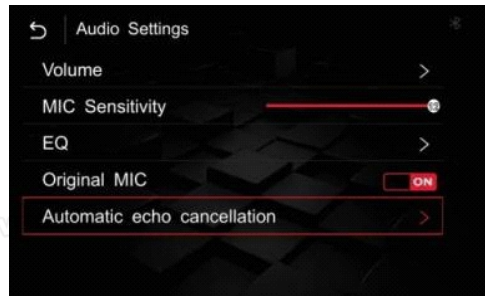

Language setting:

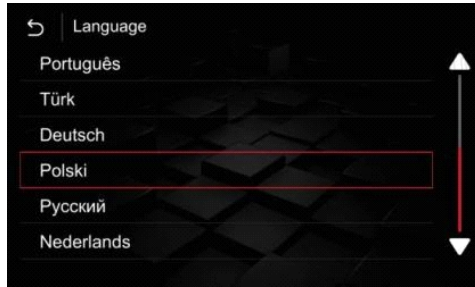

Microphone Settings:

Original car Bluetooth phone mode: Original MIC---ON

Additional microphone mode: Original MIC---OFF

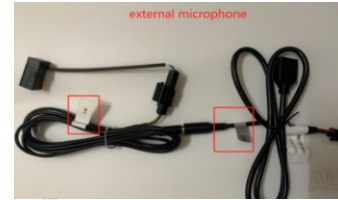
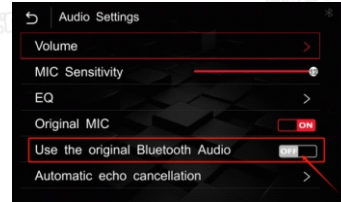

Audio Settings:

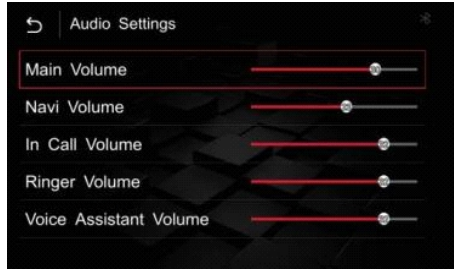

Sound channel:

Using the original external sound aux:use the original bluetooth audio---OFF

Using the original Bluetooth audio:use the original bluetooth audio---ON(The phone needs to be connected to the original Bluetooth audio.)

Audio settings are commonly operated as shown, and default values are generally recommended.

How to reset the system:(left and right driving)

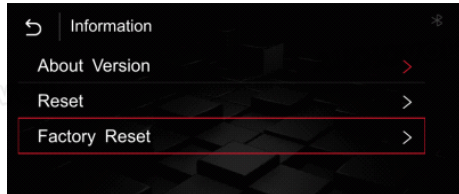

NAC Installation Diagram

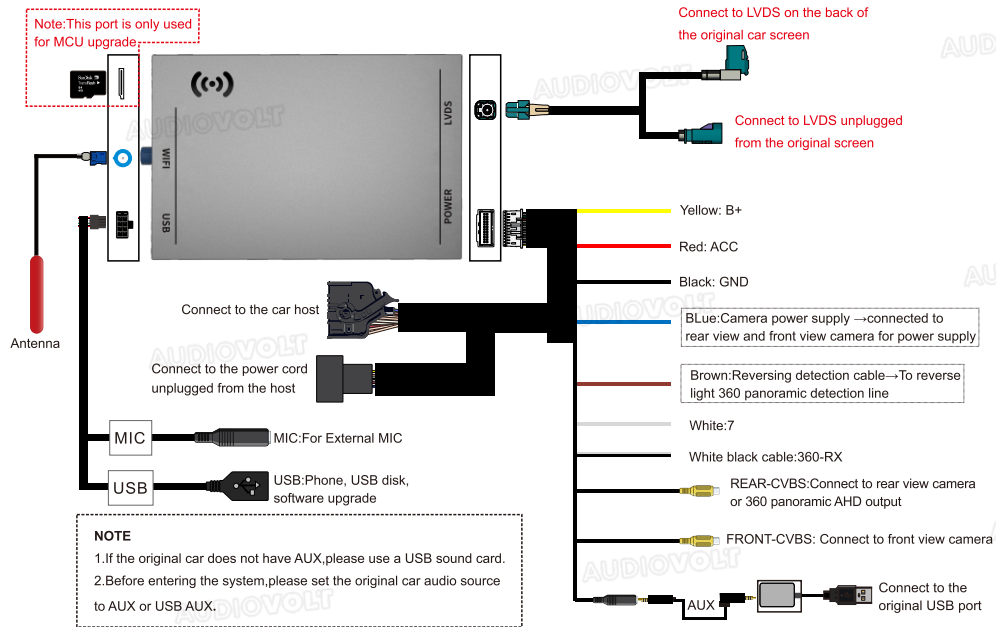

17-18 PSA NAC System Setting

| 1 | 2 | 3 | 7 | Car Model | 8 |
|-----|-----|-----|-------------|-------------------------------------|-----|
| OFF | OFF | OFF | / | LIST and PHONE in two buttons on SW | / / |
| ON | OFF | OFF | / | LIST and PHONE in one buttons on SW | / / |
| 4 | 5 | 6 | Screen Size | | |
| OFF | OFF | / | 800*480 8" | | |
| OFF | ON | / | 800*480 7" | | |

ON

OFF

1 2 3 4 5 6 7 8

ON ↑

OFF ↓ ON ↑

Instructions for using steering wheel buttons



1. Long press to switch system
2. Short press to answer a call, hang up a call or activate voice control
3. Short press to increase or decrease the volume

Important tips:

During the installation process, the power needs to be turned off.

When changing the DIP CODE, the power cord of the box needs to be unplugged.

The LVDS cable of the NAC system is connected to the LVDS socket behind the screen

The LVDS cable of the SMEG system is connected to the LVDS socket behind the CD host.

Camera setting:

Automatic transmission

- 1 Select the rear camera in the camera setting
- 2 Connect the blue wire (cam power) to the camera
- 3 Connect the trunk camera power wire together
(connect these two red cables together)

Manual transmission

- 1 Select the 360 camera in the camera setting
- 2 Connect the brown wire (360 DET)
- 3 Connect the trunk camera power wire to the reverse lamp 12V
(some cars need to connect a rectifier)

The original car does not reverse image should also be so connected like this.

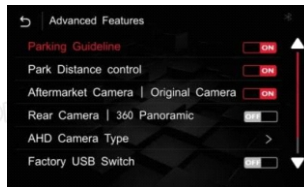
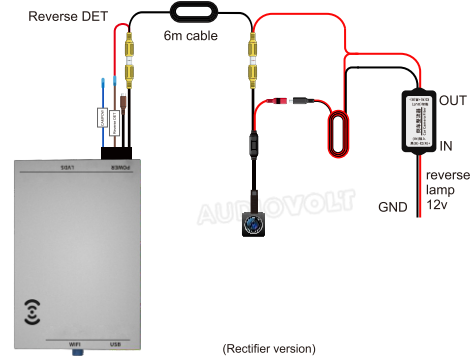
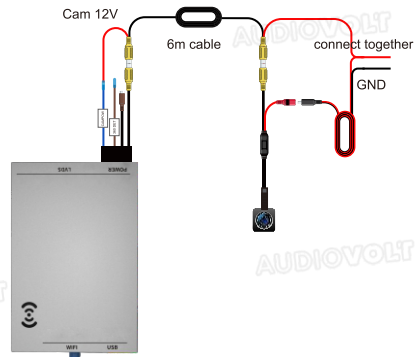

Original car with reversing camera: aftermarket camera/original camera---ON

Retrofitting a back-up camera: aftermarket camera/original camera---OFF

rear view settings as pictured above, if you add an AHD camera you need to enter the

AHD there to select the frame rate